



Operating Manual

iANT200 Series of Antennas



This page is intentionally left blank.

Document Number **320157** (See Last Page for Revision Details)

©2006 Extronics Limited. This document is Copyright Extronics limited.
Extronics reserve the right to change this manual and its contents without notice, the latest version applies.

Contents

1	Introduction.....	4
2	Safety Information and Notes	5
2.1	Storage of this Manual	5
2.2	List of Notes	5
2.3	Intended Purpose Usage.....	7
2.4	Transportation and Storage.....	7
2.5	Authorized Persons	7
2.6	Cleaning and Maintenance.....	7
2.7	Safety Precautions	8
2.8	Cleaning and Maintenance Intervals	8
2.9	Aggressive substances and environments	8
2.10	Exposure to external stresses	8
3	Mounting Details.....	9
3.1	iANT200	9
3.2	iANT201	9
3.3	iANT202	10
3.4	iANT207	10
3.5	iANT208	11
3.6	iANT209	11
3.7	iANT210	12
4	Technical Data	13
4.1	iANT200	13
4.2	iANT201	15
4.3	iANT202	16
4.4	iANT207	17
4.5	iANT208	18
4.6	iANT209	19
4.7	iANT210	22
5	Certification	25
6	Manual Revision.....	26

1 Introduction

The iANT200 series of antennas are intrinsically safe so can be used in all hazardous areas except mining. They are classed as simple apparatus which means they can be use with almost any certified wireless hardware providing the antenna conforms to the hardware's simple apparatus specifications.

The iANT200 series provides a comprehensive selection of antennas which can operate in the 2.4GHz or 5.8GHz bands; it can be used indoors or outdoors. They have an IP rating of IP66.

The table below summaries the various iANT200 options;

Antenna	Frequency	Gain	Azimuth Beamwidth	Temperature Range (T-Class & Hardware Dependant – Contact Extronics)
iANT200-24	2.4GHz	5 dBi	Omni Directional	-30°C to 80°C
iANT200-58	5.8GHz	8 dBi	Omni Directional	-30°C to 80°C
iANT201-24	2.4GHz	6 dBi	Omni Directional	-40°C to 80°C
iANT201-58	5.8GHz	10 dBi	Omni Directional	-40°C to 80°C
iANT202-24	2.4GHz	8.5 dBi	80°	-40 °C to 80°C
iANT207-24	2.4GHz	4 dBi	Omni Directional	-40°C to 80°C
iANT208-24	2.4GHz	5 dBi	135°	-40 °C to 60°C
iANT209-24-14	2.4GHz	14 dBi	38°	-40 °C to 80°C
iANT209-24-19	2.4GHz	19 dBi	21°	-40 °C to 80°C
iANT209-58-13	5.8GHz	13 dBi	35°	-40 °C to 80°C
iANT209-58-19	5.8GHz	19 dBi	20°	-40 °C to 80°C
iANT209-58-23	5.8GHz	23 dBi	10°	-40 °C to 80°C
iANT210-24-90	2.4GHz	13.5 dBi	90°	-40 °C to 80°C
iANT210-24-120	2.4GHz	12 dBi	120°	-40 °C to 80°C
iANT210-58-90	5.8GHz	15.5 dBi	90°	-40 °C to 80°C
iANT210-58-120	5.8GHz	14 dBi	120°	-40 °C to 80°C

Table 1.1 – iANT200 Summary

2 Safety Information and Notes

2.1 Storage of this Manual

Keep this user manual safe and in the vicinity of the device. All persons who have to work on or with the device should be advised on where the manual is stored.

2.2 List of Notes

The notes supplied in this chapter provide information on the following.

- **Danger / Warning.**
 - Possible hazard to life or health.
- **Caution**
 - Possible damage to property.
- **Important**
 - Possible damage to enclosure, device or associated equipment.
- **Information**
 - Notes on the optimum use of the device

Warning	The iANT200 series are classified as simple apparatus. The application in which any antennas are to be used, must be assessed for Uo, Io, maximum permissible capacitance and inductance, and PCB width trace/wire gauge in accordance with BS EN 60079-11:2007. Do not use an iANT200 antenna without first contacting Extronics for guidance and recommendations for the use of the iANT200s with specific hardware.
----------------	--

Warning	The iANT200 series enclosures are an electrostatic charging hazard; clean only with a damp cloth. The iANT200 antennas should have a label fixed to the enclosure stating that they are an electrostatic hazard.
----------------	--

Important	The iANT200 series may be used in zones 1 and 2 with flammable gases and vapours with apparatus groups IIA, IIB & IIC and temperature classes specific to the antenna used.
------------------	---

Important	iANT200's are only certified for use in ambient temperatures in the ranges specified in table 1.1 and should not be used outside this range.
------------------	--

Important	Do not exceed the Effective Isotropic Radiated Power (EIRP) limit for the country/region of operation
------------------	---

Warning	The maximum radiated power must not exceed that allowed in the area of installation (BS 6656:2002). IIC -2W, IIB – 3.5W, IIA – 6W
----------------	---

Important	Installation of this equipment shall be carried out by suitably trained personnel in accordance with the applicable code of practice (EN 60079-14).
------------------	---

Important If the flying lead is terminated in the hazardous area, it is required to be installed in an appropriately certified enclosure.

Important The antennas and associated wiring should be periodically inspected for damage, in accordance with the applicable code of practice (EN 60079-17)

Important Repair of the iANT200 shall only be carried out by the manufacturer: The antenna contains no user-serviceable parts.

2.3 Intended Purpose Usage

Important	Before setting the units to work, read the technical documentation carefully.
------------------	--

Important	The latest version of the technical documentation or the corresponding technical supplements is valid in each case.
------------------	--

The iANT200 series is built using modern components and is extremely reliable in operation; however it must only be used for its intended purpose. Please note that the intended purpose also includes compliance with the instructions issued by the manufacturer for installation, setting up and service.

Any other use is regarded as conflicting with the intended purpose. The manufacturer is not liable for any subsequent damage resulting from such inadmissible use. The user bears the sole risk in such cases.

2.4 Transportation and Storage

All iANT200 series devices must be so transported and stored that they are not subjected to any excessive mechanical stresses.

2.5 Authorized Persons

Only persons trained for the purpose are authorized to handle the iANT200 series; they must be familiar with the unit and must be aware of the regulation and provisions required for explosion protection as well as the relevant accident prevention regulations.

2.6 Cleaning and Maintenance

The iANT200 series and all its components require no maintenance. All work on the iANT200 series by personnel who are not expressly qualified for such activities will cause the Ex approval and the guarantee to become void.

Warning	The iANT200 series enclosures are an electrostatic charging hazard; clean only with a damp cloth. The iANT200 antennas should have a label fixed to the enclosure stating that they are an electrostatic hazard.
----------------	---

2.7 Safety Precautions

Important	For the installation, maintenance and cleaning of the units, it is absolutely necessary to observe the applicable regulations and provisions concerned with explosion protection (EN 50014, EN 60079-14:2003) as well as the Accident Prevention Regulations.
------------------	---

Warning	The maximum radiated power must not exceed that allowed in the area of installation (BS 6656:2002). IIC -2W, IIB – 3.5W, IIA – 6W
----------------	---

2.8 Cleaning and Maintenance Intervals

The cleaning intervals depend on the environment where the system is installed.

2.9 Aggressive substances and environments

The iANT200 series is not designed to come into contact with aggressive substances or environments, please be aware that additional protection may be required.

2.10 Exposure to external stresses

The iANT200 series is not designed to be subjected to excessive stresses e.g. vibration, heat, impact. Additional protection is required to protect against these external stresses.

The iANT200 series will require additional protection if it is installed in a location where it may be subjected to damage.

3 Mounting Details

3.1 iANT200

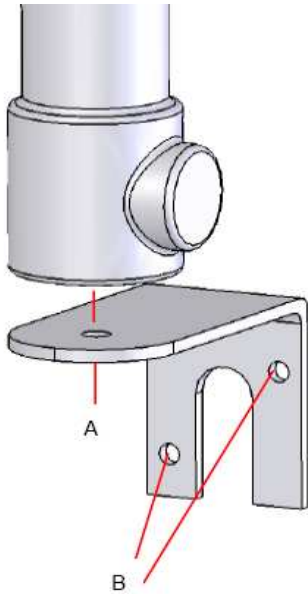

Place the antenna bracket into desired location as stipulated in the report and mark the “B” holes.

Remove the bracket and drill two holes using a 6mm drill approximately 30mm deep.

Plug the holes using the red rawl plugs.

Re-align the bracket and fix using suitable screws.

Place the antenna onto the bracket and fix through “A” using M6 lock washer & M6 x10 slotted machine screw.

Attach connector to RF equipment and tidily secure excess cable.

3.2 iANT201

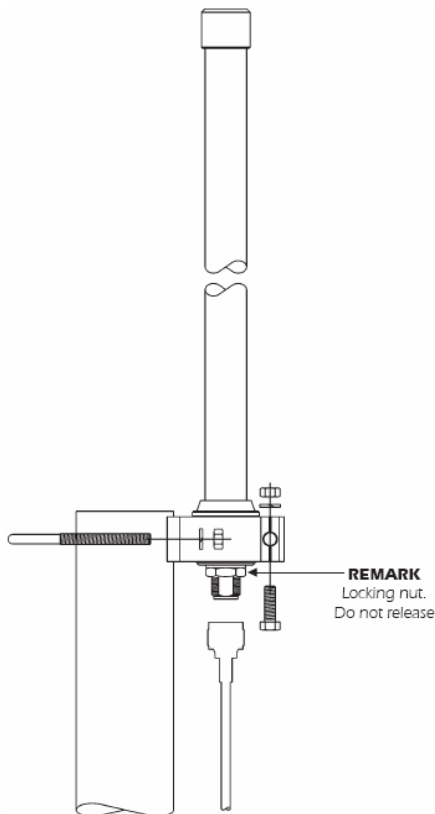

Fix the iANT201 into the clamp using a suitable bolt, washer and nut.

Using the fixings supplied, place the U-Bolt around the 60mm pipe and through the appropriate holes on the antenna clamp

Attach RF Cable to the N-Type connector on the underside of the antenna and tidily secure excess cable.

3.3 iANT202

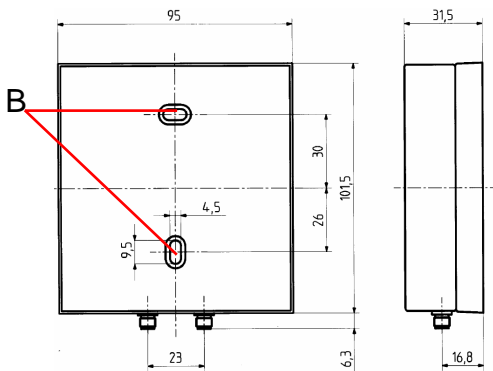

Place the antenna bracket into desired location and mark the “B” holes.

Remove the bracket and drill two holes using a 6mm drill approximately 30mm deep.

Plug the holes using the red rawl plugs.

Re-align the bracket and fix using suitable screws.

Clip the iANT202 into the bracket so that it sits firmly.

Attach connector to RF equipment and tidily secure excess cable.

3.4 iANT207

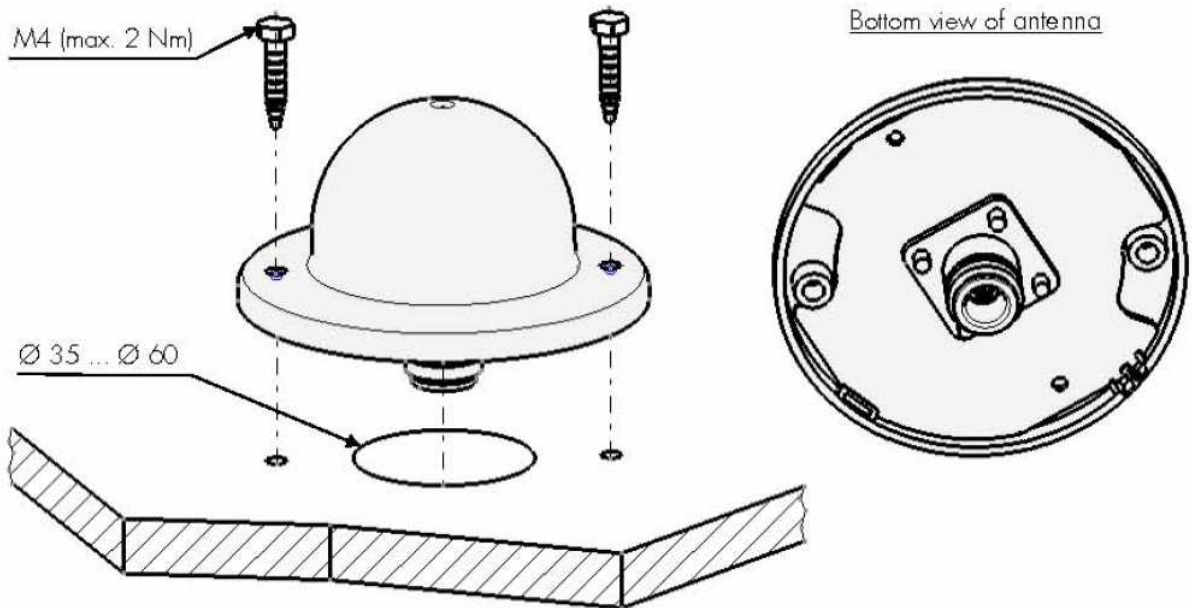

3.5 iANT208

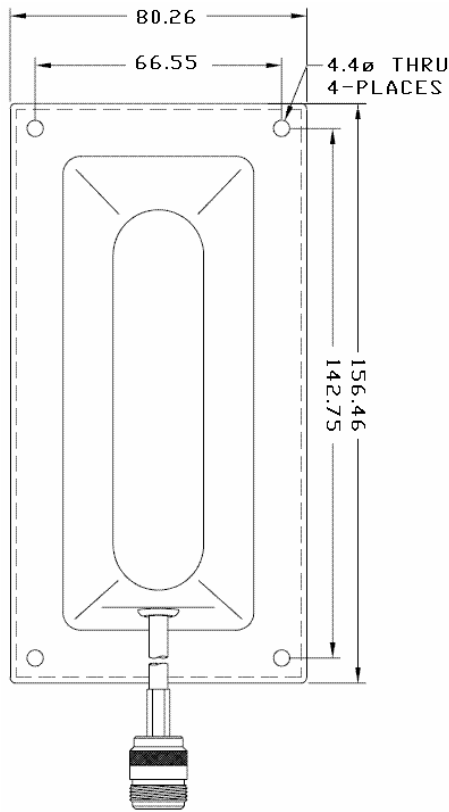

The iANT208 is a wall mounted antenna

Mount directly to a wall, the fixings are shown (right)

Attach connector to RF equipment and tidily secure excess cable.

3.6 iANT209

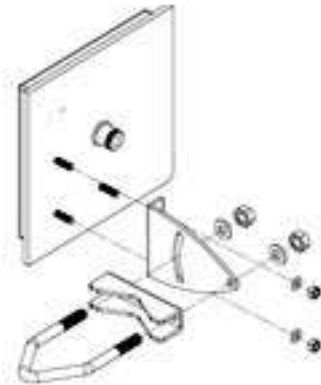

Assemble the mounting kit as shown.

You can adjust the tilt and orientation of the antenna to suit application.

The mounting kit is designed for a 50mm pipe (2").

Attach connector to RF equipment and tidily secure excess cable.

3.7 iANT210

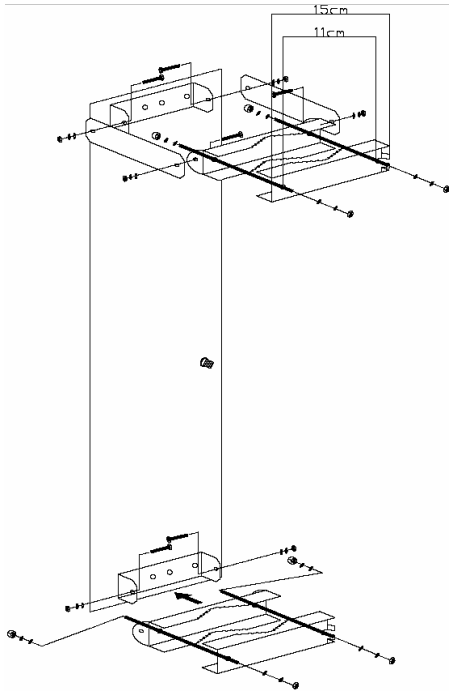

Assemble the mounting kit as shown.

You can adjust the tilt and orientation of the antenna to suit application.

The mounting kit is designed for a 50mm pipe (2").

Attach connector to RF equipment and tidily secure excess cable.

4 Technical Data

4.1 iANT200

Dimensions	2.4GHz — 175mm Length, 28mm Diameter 5.8GHz — 205mm Length, 29mm Diameter
Weight	100g
Connections	Dependent on part number (BNC/TNC/SMA + Others on request)
Cable Sealed Lead Length	Supplied as 1 or 5 metre (Others on request)
Frequency Range	2.3—2.5 GHz 5.15—5.875 GHz
Bandwidth	100MHz
Impedance	50 Ohms
Return Loss	Better than 12 dB
Gain	5 dBi @ 2.4 GHz 8 dBi @ 5.8 GHz
VSWR	<2:1
Azimuth (Horizontal) 3dB beamwidth	360°
Elevation (Vertical) 3dB beamwidth	35°
Radiation Angle	0°
Polarization	Vertical
Radiator Element	Brass tubing
Tube Material	GRP, colour white
Base Material	Delrin™
Ambient Temperature	-30°C to 80°C
IP Rating	IP66
Certification	II 1 G Ex ia IIC T5/T6
Certification Type	Simple Apparatus

iANT200 E Plane Radiation Pattern

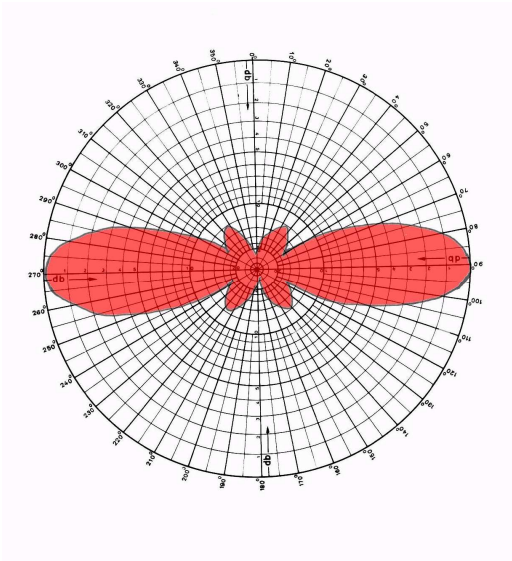

iANT200 H Plane Radiation Pattern

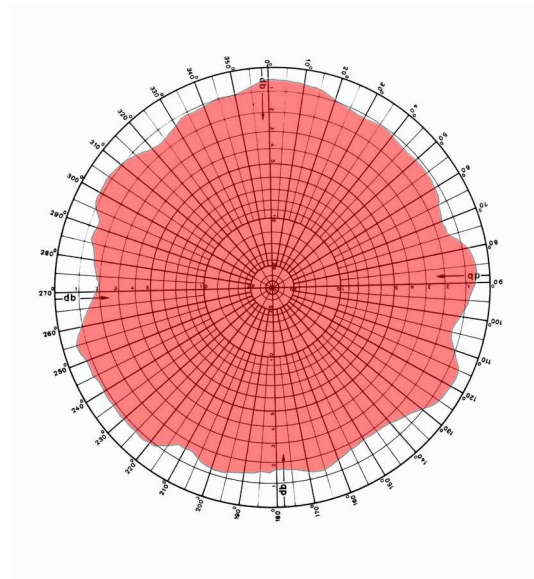

4.2 iANT201

Dimensions	2.4GHz - 330mm Length, 23/32mm Diameter 5.8GHz - 400mm Length, 23/32mm Diameter
Weight	2.4GHz - Approx 350g 5.8GHz - Approx 500g
Connections	N-Type Female
Frequency Range	2.3 - 2.5 or 5.470 - 5.875 GHz
Impedance	50 Ohms
Gain	2.4GHz - 6 dBi 5.8GHz - 10dBi
VSWR	≤1.5:1
Azimuth Beamwidth (3dB)	2.4GHz=360° , 5.8GHz =360°
Elevation Beamwidth (3dB)	2.4GHz=22° , 5.8GHz =10°
Radiation Angle	2.4GHz=0° , 5.8GHz =0°
Polarisation	Vertical
Ambient Temperature	-40°C to 80°C
IP Rating	IP66
Certification type	Simple Apparatus
Certification	II 1 G Ex ia IIC T4

iANT201-24 E Plane Radiation Pattern

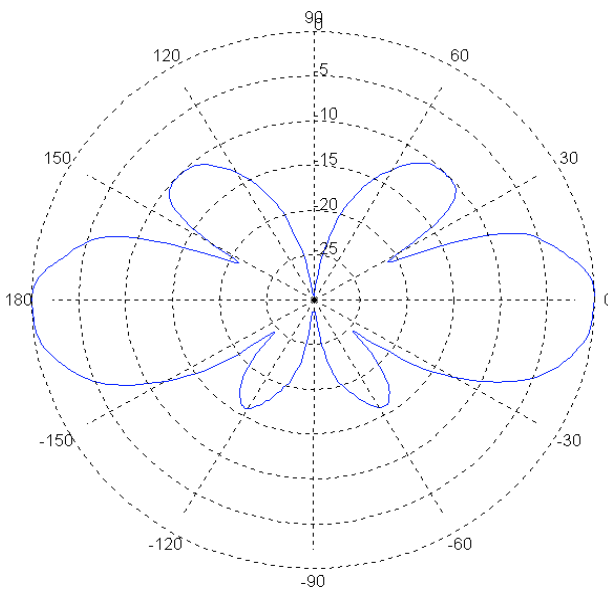

iANT201-58 E Plane Radiation Pattern

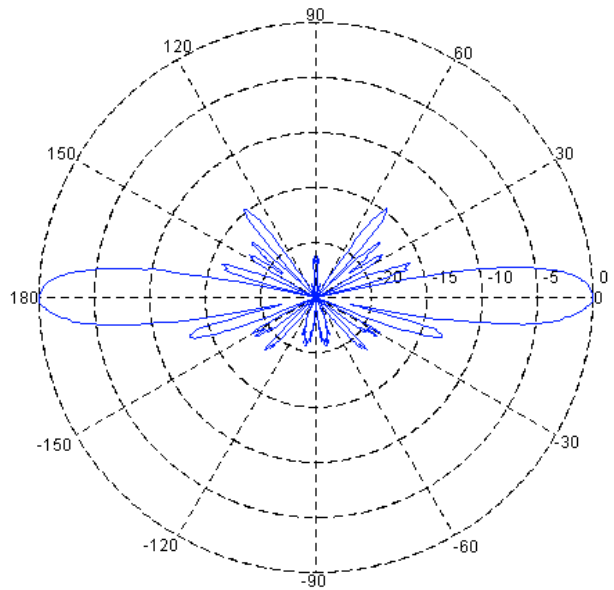

4.3 iANT202

Dimensions	101 x 95 x 32 mm (3.98" x 3.74" x 1,26")
Weight	110g (0.24 lbs.)
Connections	Antenna: SMA Male x 2
Frequency Range	2.3 - 2.5 GHz
Impedance	50 Ohms
Gain	8.5 dBi
VSWR	1.5
Polarisation	Dual Linear, $\pm 45^\circ$ slant
Azimuth Beam width (3dB)	80°
Elevation Beam width (3dB)	70°
Down tilt	0°
Port-port isolation	30dB
Front-back ratio	18dB
IP Rating	IP54
Certification Type	Simple Apparatus
Certification	II 1 G Ex ia IIC T5/T6

iANT202 E Plane Radiation Pattern

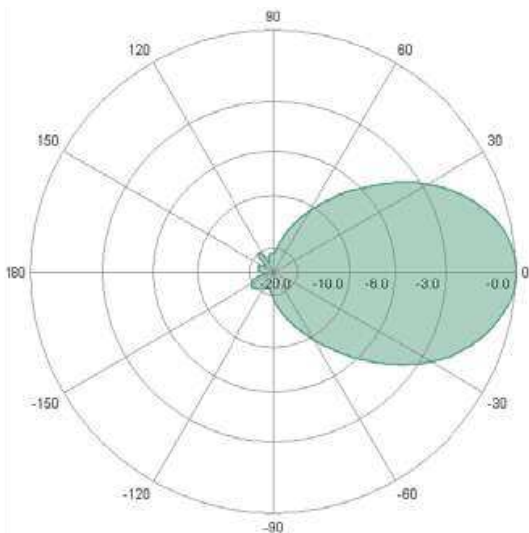

iANT202 H Plane Radiation Pattern

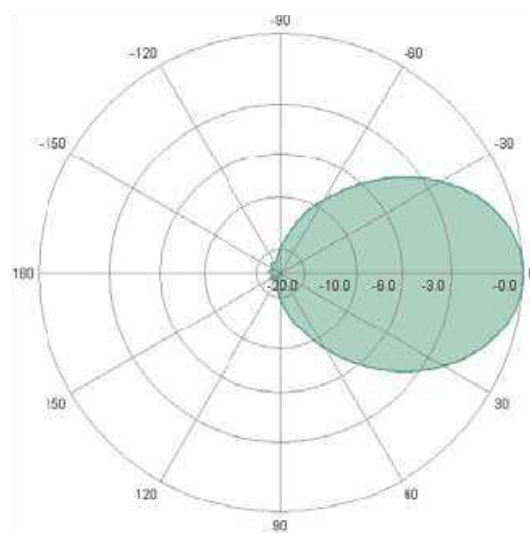

4.4 iANT207

Dimensions	86mm diameter, 43mm high
Weight	300g
Connections	N-Type Female
Frequency Range	2.4 – 2.5 GHz
Impedance	50 Ohms
Gain	4dBi
VSWR	1.5:1
Azimuth (Horizontal) 3dB Beamwidth	360°
Elevation (Vertical) 3dB Beamwidth	25°
Uptilt	20°
Polarization	Linear, vertical
Ambient Temperature	-40°C to 80°C
IP Rating	IP66
Certification Type	Simple Apparatus
Certification	II 1 G Ex ia IIC T5/T6

iANT 207 E Plane Radiation Pattern

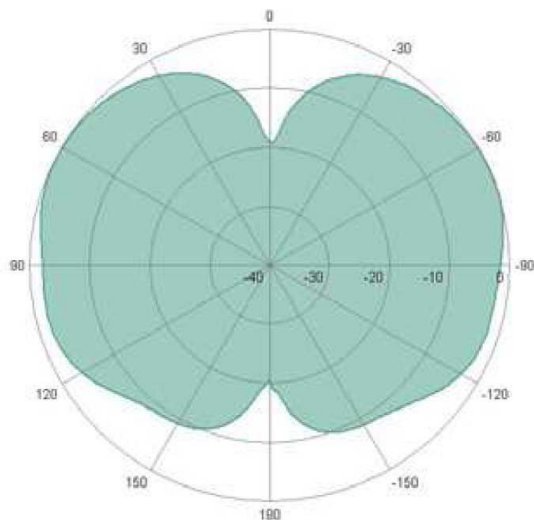

iANT207 H Plane Radiation Pattern

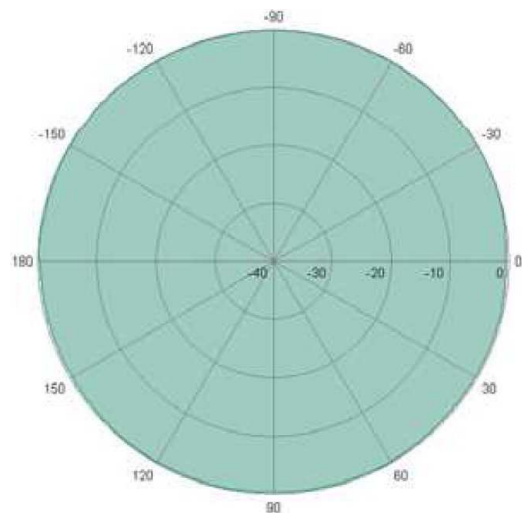

4.5 iANT208

Dimensions	152.4mm x 76.2mm x 48.8mm
Weight	140g
Connections	N-type
Frequency Range	2.4 – 2.5 GHz
Impedance	50 Ohms
Gain	5dBi
VSWR	1.5:1
Azimuth (Horizontal) 3dB Beamwidth	135°
Elevation (Vertical) 3dB Beamwidth	55°
Polarization	Linear
Ambient Temperature	-40°C to 60°C
IP Rating	IP54
Certification Type	Simple Apparatus
Certification	II 1 G Ex ia IIC T5/T6

- iANT208 -24 H-Plane
- iANT208 -24 E-Plane

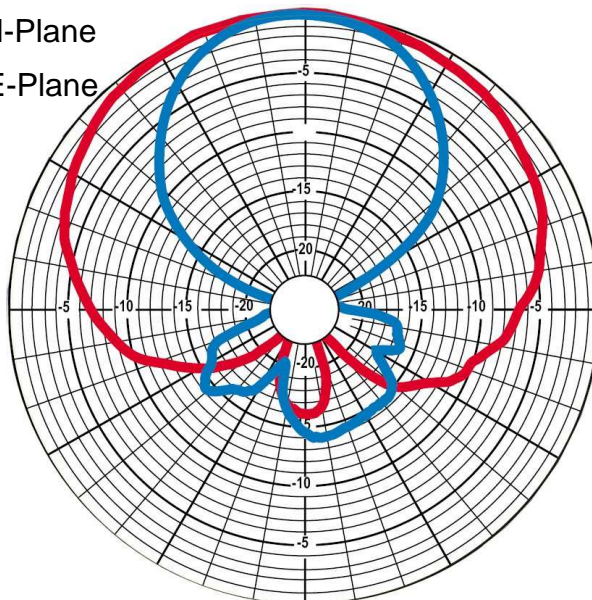

4.6 iANT209

Dimensions	iANT209-24-14 = 165 x 165 x 35 mm iANT209-24-19 = 330 x 330 x 40 mm iANT209-58-13 = 88 x 88 x 35 mm iANT209-58-19 = 165 x 165 x 35 mm iANT209-58-23 = 330 x 330 x 40 mm
Weight	iANT209-24-14 = 0.35 Kg iANT209-24-19 = 1.15Kg iANT209-58-13 = 0.2 Kg iANT209-58-19 = 0.35 Kg iANT209-58-23 = 1.15 Kg
Connections	N-Type Female
Frequency Range	2.4 - 2.5 or 5.1 - 5.9 GHz
Impedance	50 Ohms
Gain	iANT209-24-14 = 11.9 dBd / 14 dBi iANT209-24-19 = 16.9 dBd / 19 dBi iANT209-58-13 = 13 dBi ± 0.5dBi iANT209-58-19 = 19 dBi ± 0.5dB iANT209-58-23 = 23 dBi ± 0.5dB
VSWR	iANT209-24-14 = < 2 iANT209-24-19 = < 2 iANT209-58-13 = < 1.5 iANT209-58-19 = < 1.5 iANT209-58-23 = < 2
Azimuth (Horizontal) 3dB Beamwidth	iANT209-24-14 = 38° iANT209-24-19 = 21° iANT209-58-13 = 35° iANT209-58-19 = 20° iANT209-58-23 = 10°
Elevation (Vertical) 3dB Beamwidth	iANT209-24-14 = 39° iANT209-24-19 = 20° iANT209-58-13 = 35° iANT209-58-19 = 20° iANT209-58-23 = 10°
Front-Back Ratio	iANT209-24-14 = > 20 dB iANT209-24-19 = > 22 dB iANT209-58-13 = > 24 dB iANT209-58-19 = > 25 dB iANT209-58-23 = > 25 dB
Polarization	Vertical or Horizontal
Ambient Temperature	-40°C to 80°C
IP Rating	IP68
Certification	II 1 G Ex ia IIC T5/T6
Certification Type	Simple Apparatus

iANT209-24-14 (E Plane) Radiation Pattern

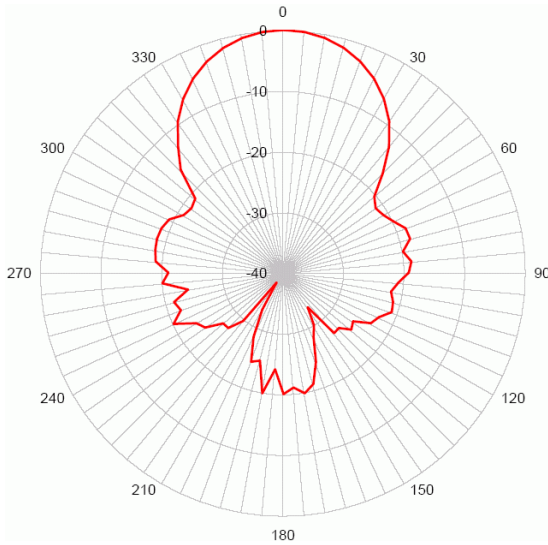

iANT209-24-14 (H Plane) Radiation Pattern

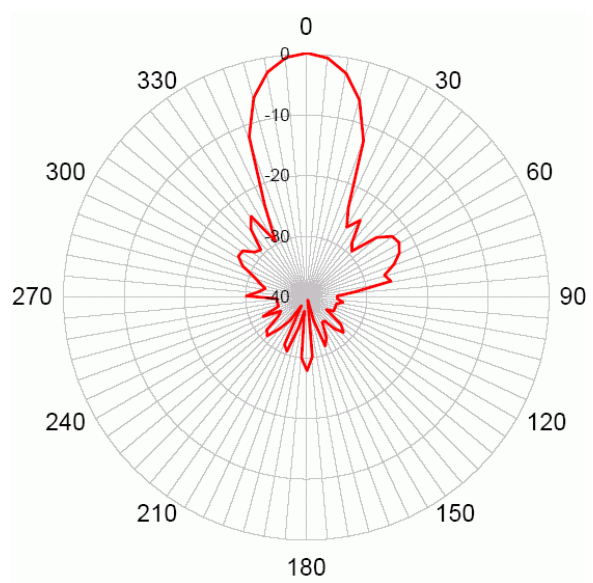

iANT209-24-19 (E Plane) Radiation Pattern

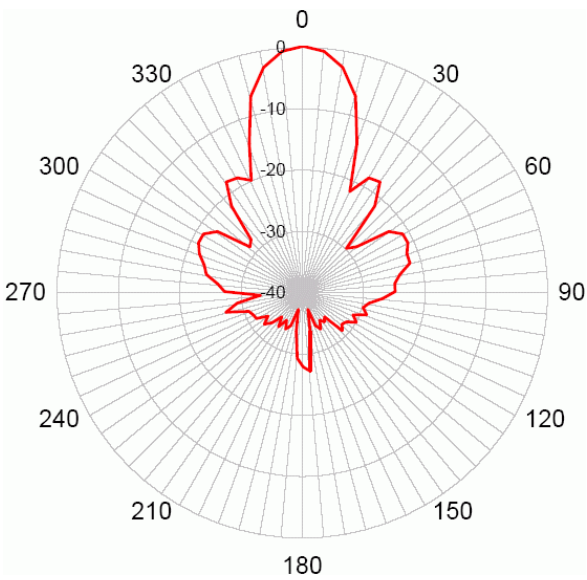

iANT209-24-19 (H Plane) Radiation Pattern

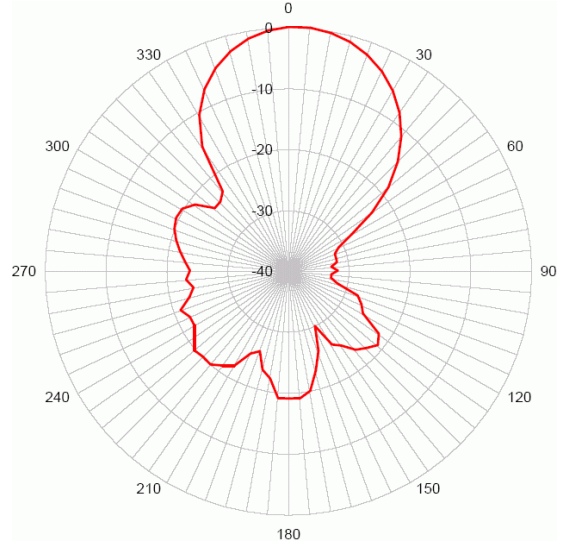

iANT209-58-13 (E Plane) Radiation Pattern

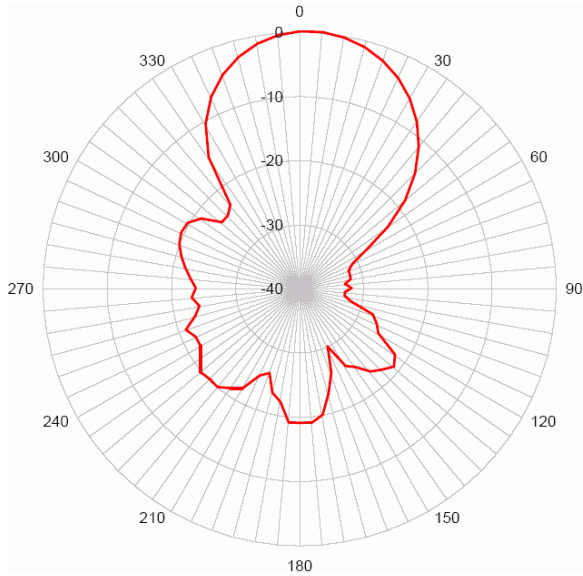

iANT209-58-13 (H Plane) Radiation Pattern

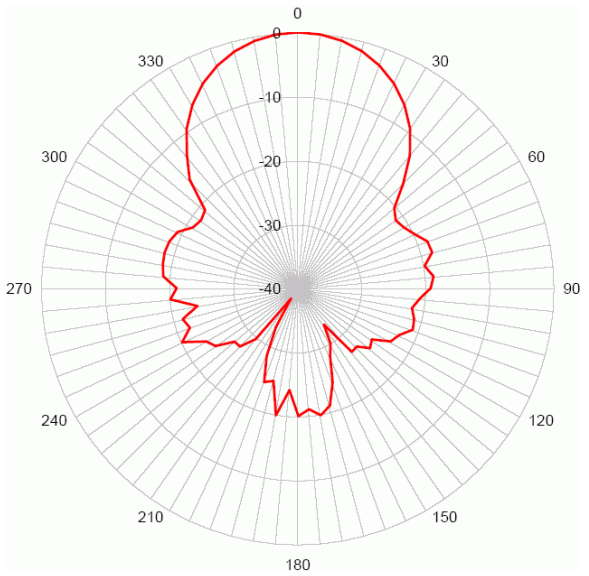

iANT209-58-19 (E Plane) Radiation Pattern

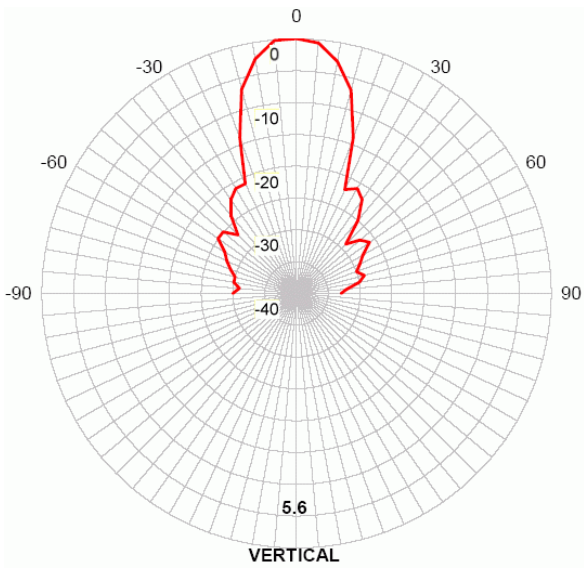

iANT209-58-19 (H Plane) Radiation Pattern

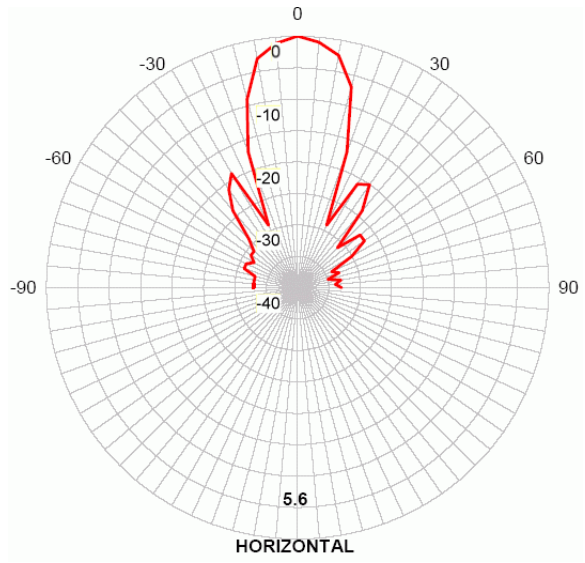

iANT209-24-14 (E Plane) Radiation Pattern

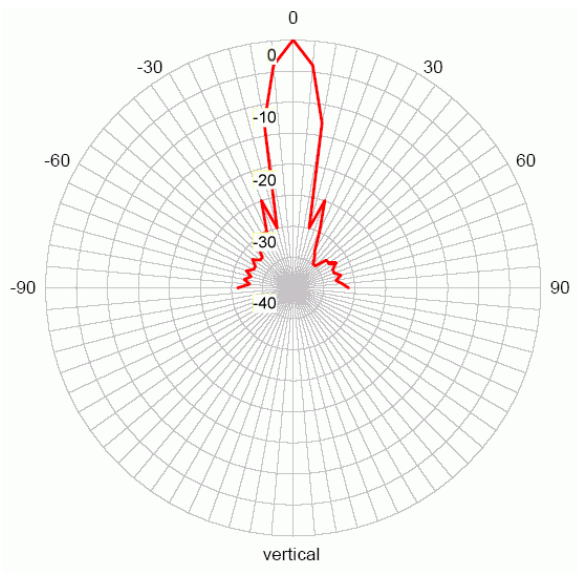

iANT209-24-14 (H Plane) Radiation Pattern

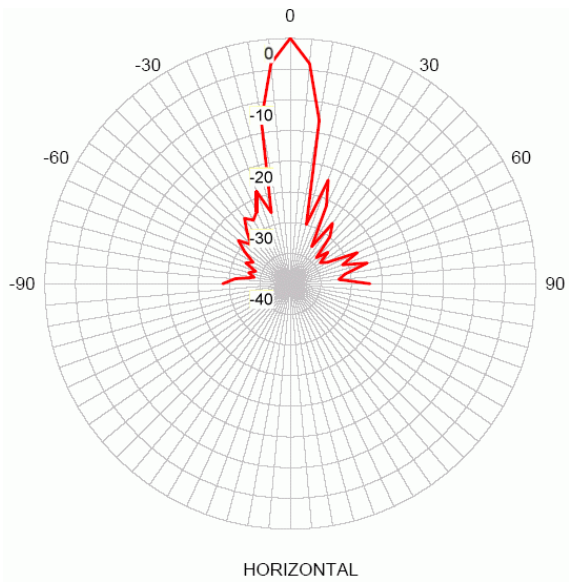

4.7 iANT210

Dimensions	435 x 225 x 75 mm
Weight	Approx 1Kg
Connections	N-Type Female
Frequency Range	2.4 - 2.485 or 5.75 - 5.85 GHz
Impedance	50 Ohms
Gain	iANT210-24-90 = 13.5 dBi iANT210-24-120 = 12 dBi iANT210-58-90 = 15.5 dBi iANT210-58-120 = 14 dBi
VSWR	1.8 : 1
Azimuth (Horizontal) 3dB Beamwidth	iANT210-24-90 = 90° iANT210-24-120 = 120° iANT210-58-90 = 90° iANT210-58-120 = 120°
Elevation (Vertical) 3dB Beamwidth	iANT210-24-90 = 15° iANT210-24-120 = 15° iANT210-58-90 = 8° iANT210-58-120 = 8°
Downtilt	Variable 0° - 25°
Front-back ratio	iANT210-24-90 = 31dB iANT210-24-120 = 27dB iANT210-58-90 = 28dB iANT210-58-120 = 26dB
Polarisation	Vertical
Ambient Temperature	-40°C to 80°C
IP Rating	IP65
Certification Type	Simple Apparatus
Certification	II 1 G Ex ia IIC T5/T6

iANT210-24-90 (E Plane) Radiation Pattern

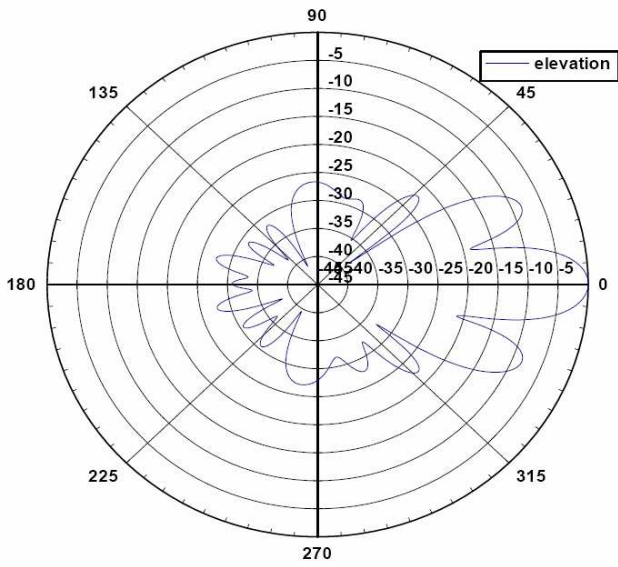

iANT210-24-90 (H Plane) Radiation Pattern

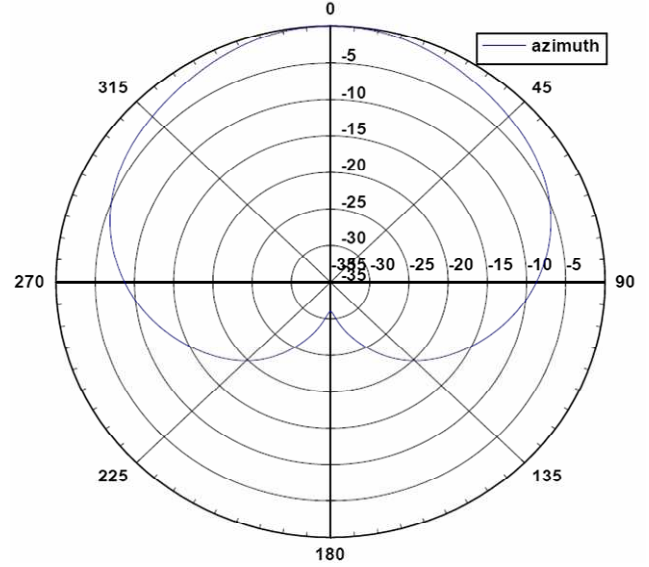

iANT210-24-120 (E Plane) Radiation Pattern

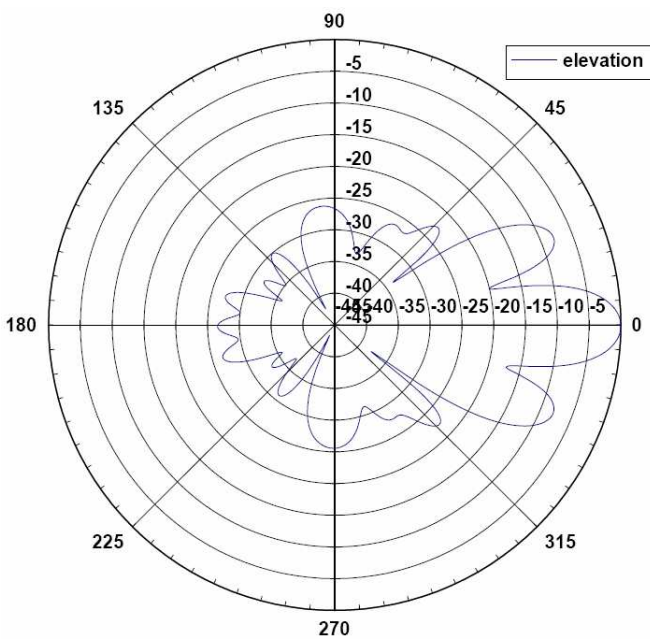

iANT210-24-120 (H Plane) Radiation Pattern

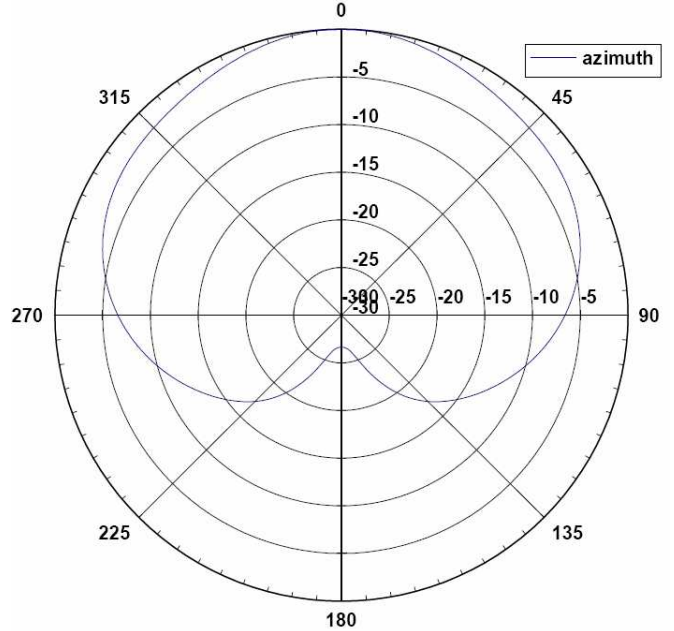

Operating Manual

iANT210-58-90 (E Plane) Radiation Pattern

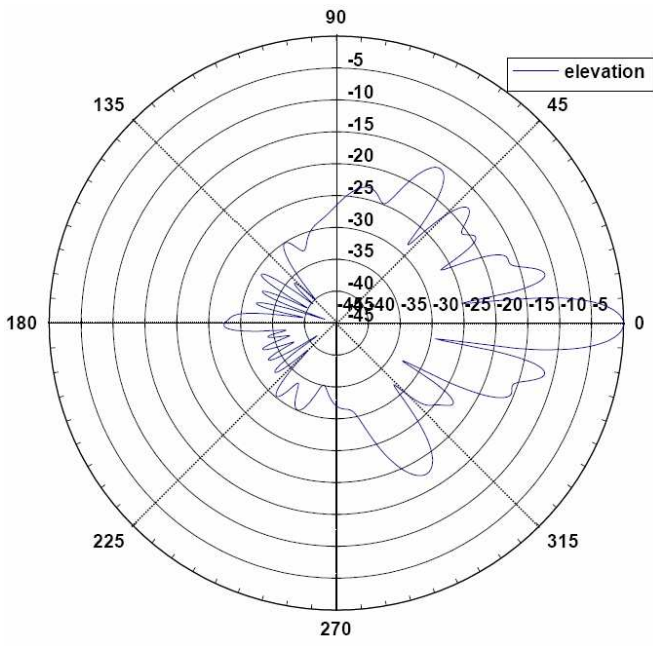

iANT210-58-90 (H Plane) Radiation Pattern

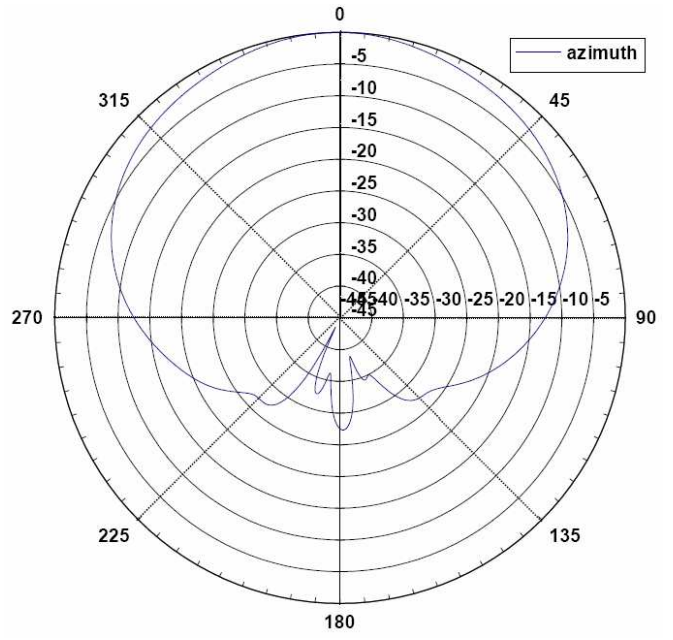

iANT210-58-120 (E Plane) Radiation Pattern

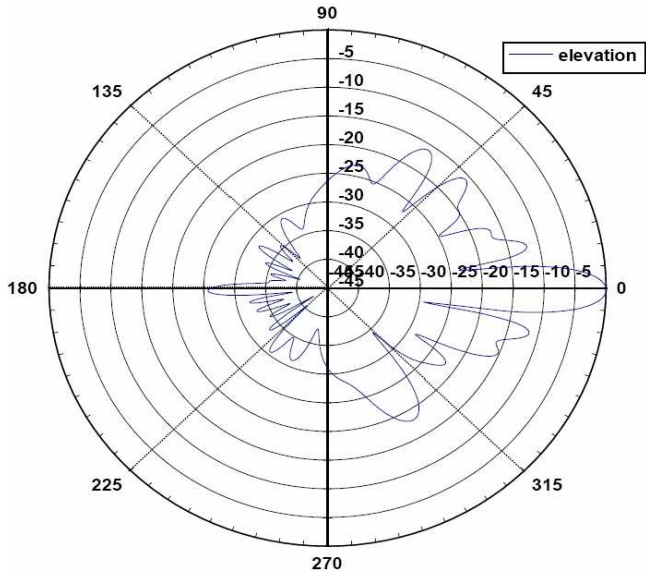

iANT210-58-120 (H Plane) Radiation Pattern

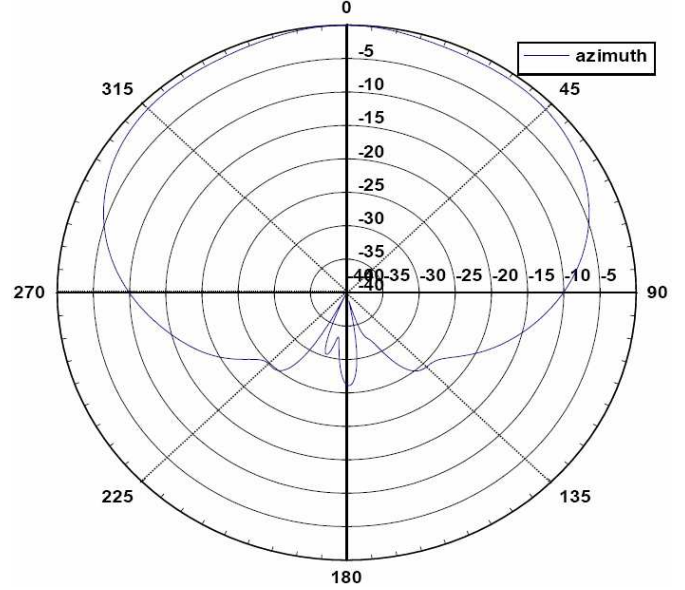

5 Certification



EC Declaration of Conformity

Extronics Ltd, Meridian House, Roe street, Congleton, CW12 1PG UK

Declare under sole responsibility that the product;

iANT2xx-xx-xx

To which this declaration relates is in accordance with the provision of the following directives

94/9/EC Equipment and protective systems intended for use in potentially explosive atmospheres.

And is in conformity with the following standards or other nominative documents

BS EN 60079-0:2006	Electrical apparatus for explosive gas atmospheres - General requirements
BS EN 60079-11:2007	Explosive atmospheres - Equipment protection by intrinsic safety 'I'

Signed

Date : 30/05/08

A handwritten signature in black ink, appearing to read 'Nick Saunders', is written over a horizontal line.

Nick Saunders
Technical Services Manager

6 Manual Revision

Revision	Description	Date	By
01	Initial Release	19/05/08	AJR
02	iANT200-58 Added	15/01/09	NE
03	Added EC Declaration	10/02/09	JE
04	Updated Antenna Range, Added Mounting Instructions	11/06/09	JE