



sonim.  
BUILT FOR LIFE™

**XP5s**

# USER GUIDE

## GENERAL INFORMATION

Copyright © 2018 Sonim Technologies, Inc. Sonim and the Sonim logo are trademarks of Sonim Technologies, Inc. Other company and product names may be trademarks or registered trade-marks of the respective owners with whom they are associated.

### DISPOSAL OF OLD ELECTRICAL AND ELECTRONIC EQUIPMENT



The symbol of the crossed-out wheeled bin indicates that within the countries in the European Union, this product, and any enhancements marked with this symbol, cannot be disposed as unsorted waste but must be taken to separate collection at their end-of-life.

### DISPOSAL OF BATTERY



Please check local regulations for disposal of batteries. The battery should never be placed in municipal waste. Use a battery disposal facility if available.

### GUIDELINE FOR HEADPHONE AND EARPHONE



To prevent possible hearing damage, please do not listen at high volume levels for long period.

### REGISTER YOUR PHONE

Please register your phone at [www.sonimtech.com/register](http://www.sonimtech.com/register), to receive product information and updates.



Sonim devices are covered by a 3-Year comprehensive warranty. The embedded battery is covered by a 1-Year limited warranty.

Congratulations on the purchase of a Sonim XP5800 mobile phone! This phone is an LTE enabled feature phone and has an intuitive feature-rich user interface,

which allows you to make the best use of offered functions.

### PHONE MODELS COVERED

This user guide covers Sonim XP5s phone with the model number XP5800.

### SONIM SUPPORT INFORMATION

For additional product and support information, visit [www.sonimtech.com](http://www.sonimtech.com).

### OPTIONS COMMONLY USED ACROSS MENU ITEMS

The following are common actions used across various menu items:

<b>OK</b>	Confirms an action. Use the <b>Center</b> key to perform this function.
<b>BACK</b>	Use this key to display the previous screen.
<b>MENU</b>	Moves the current working application to the recent applications list/background and displays menu screen.
<b>RECENT</b>	Displays the thumbnails of the applications that you have worked on recently. To remove any application from this list, Select <b>Remove</b> from list from option.

<b>GENERAL INFORMATION</b>	<b>2</b>	Search.....	16
Disposal of Old Electrical and Electronic Equipment.....	2	Home Screen Shortcuts.....	16
Disposal of Battery.....	2	System Settings.....	16
Guideline for Headphone and Earphone.....	2	Manage Apps.....	16
Register your phone.....	2		
Phone Models Covered.....	2	<b>QUICK SETTINGS</b>	<b>17</b>
Sonim Support Information.....	2	Wi-Fi.....	17
Options Commonly Used Across Menu Items.....	2	Bluetooth.....	17
		Torch.....	17
		Airplane Mode.....	17
		Profiles.....	17
<b>SAFETY GUIDELINES</b>	<b>5</b>		
Avoid High Temperatures.....	6	<b>MISSED EVENTS</b>	<b>17</b>
Personal Medical Devices.....	6		
Child Safety.....	6	<b>MANAGING WIRELESS &amp; NETWORK</b>	
Emergency Calls.....	6	<b>SETTINGS</b>	<b>18</b>
		Wi-Fi.....	18
<b>BATTERY USAGE</b>	<b>6</b>	Bluetooth.....	18
Inserting the Battery.....	6	Data Usage.....	19
Charging the Battery.....	7	More.....	19
Warning.....	7		
Verifying and Optimizing Battery Usage.....	7	<b>MANAGING DEVICE SETTINGS</b>	<b>21</b>
Tips to Extend the Battery Life.....	8	Display.....	21
		Sound.....	21
		Apps.....	22
<b>YOUR SIM CARD</b>	<b>9</b>	USB Power Saving.....	23
Removing the Back Cover.....	9	Storage.....	23
Inserting SIM Cards.....	9	Battery.....	23
Inserting Memory Card.....	10	Memory.....	23
		Gesture.....	23
<b>GETTING STARTED</b>	<b>11</b>	<b>MANAGING PERSONAL SETTINGS</b>	<b>24</b>
What is in the Box?.....	11	Home Screen Shortcuts.....	24
Phone Specifications.....	11	Emergency Info.....	24
		Location.....	24
		Security.....	24
		Programmable Key.....	25
		Languages & Input.....	25
		Factory Reset.....	25
<b>USING YOUR SONIM XP5S</b>	<b>12</b>	<b>MANAGING SYSTEM SETTINGS</b>	<b>26</b>
Switching On the Phone.....	13	Date & Time.....	26
Setting Up Your Phone.....	13	Accessibility.....	26
Managing Home Screen.....	13	About Phone.....	26
Notification Bar Icons.....	14		
Phone Operations Without SIM Card.....	14		
Capturing a Screenshot.....	14		
to change the phone language.....	15		
Text Entry Options.....	15		
To Enter a Word.....	15		
To Insert a Number.....	15		
<b>HOME SCREEN MENU OPTIONS</b>	<b>16</b>		
My Notifications.....	16		
Wallpaper.....	16		

System Updates .....	26	Sound Recorder .....	39
		SIM Toolkit.....	39
<b>MANAGING CONTACTS</b>	<b>27</b>	<b>OTHER APPLICATIONS</b>	<b>40</b>
Adding a New Contact First Time .....	27	Camera.....	40
Adding a New Contact .....	27	Calendar .....	40
Viewing Contact Details .....	27	Browser.....	40
Sending a Message from Contacts .....	27		
Dialing a Number from Contacts.....	27	<b>REGULATORY INFORMATION - USA</b>	
Editing the Contact Details.....	27	<b>MARKET</b>	<b>41</b>
Menu options.....	27	RF Exposure Information (SAR) .....	41
Managing Contact Settings.....	29	Federal Communication Commission Interference Statement.....	41
		FCC Caution .....	42
<b>MANAGING CALL SETTINGS</b>	<b>30</b>	HAC Rating .....	42
Making a Call .....	30	ISED RF Exposure Statement (IC).....	42
Dialing a Number via Contact .....	30		
Adding a Contact from Home Screen .....	30	<b>HAZARDOUS LOCATION USAGE WARNING</b>	<b>43</b>
Viewing Call History.....	30		
Deleting Call History .....	30		
Show missed calls.....	30	<b>INDEX</b>	<b>44</b>
Speed Dial Settings .....	30		
Call Settings.....	30		
<b>SENDING MESSAGES</b>	<b>33</b>		
Sending SMS/MMS Message .....	33		
Managing Message Settings.....	33		
Deleting Messages .....	34		
<b>SPRINT DIRECT CONNECT PLUS</b>	<b>35</b>		
<b>SONIM SCOUT</b>	<b>36</b>		
Setup.....	36		
Utilities.....	36		
Support .....	36		
<b>APPLICATIONS</b>	<b>37</b>		
Music.....	37		
FM Radio.....	37		
File Explorer .....	37		
Backup and Restore .....	38		
Downloads .....	38		
Mobile Urgent Alerts.....	38		
<b>TOOLS</b>	<b>39</b>		
Clock.....	39		
Calculator.....	39		

## SAFETY GUIDELINES

Please read and understand the following safety guidelines before you use the phone. These guidelines provides you the details that enables you to operate your phone safely and conform to any legal requirements regarding the use of cellular phones.



Do not to use the phone at a refueling point. Observe restrictions when using radio equipment at fuel depots, chemical plants or where blasting operations are in progress.



Electrical interference may obstruct the use of your phone. Observe restrictions in hospitals and near medical equipment.



Switch off your cellular phone when in an aircraft. Wireless phones can cause interference or danger to an aircraft. In an aircraft, the phone can be used in flight mode.



Do not expose the device to high temperatures (in excess of 55°C).



Adhere to road safety laws. Do not hold/use a phone while you are driving; find a safe place to stop first. Use hands-free microphone while you are driving.



Avoid using the phone in close proximity to personal medical devices, such as pacemakers and hearing aids.



Use only Sonim XP5800 approved charging equipment to charge your phone and avoid damage to your phone.



The symbol of the crossed-out wheeled bin indicates that this product, and any enhancements marked with this symbol, cannot be disposed as unsorted waste but must be taken to separate collection at their end-of-life.



Ensure that only qualified personnel install or repair your phone.

The Sonim XP5800 is water-proof and can be submerged to 2 meters for 30 minutes.

Ensure to close the audio connector and SIM slot properly. This will prevent the deposit of water droplets on the connectors, when the phone is immersed in water.



Water droplets may condense under the display cover if the phone is immersed in water with significant drop in temperature. This does not indicate water leakage. The droplets will disappear at room temperature.

The Sonim XP5800 is dust-resistant, rugged and shock-resistant. However, it is not dust-proof or unbreakable if subjected to overwhelming impact. For best results and long product life, one should protect the Sonim XP5800 from salt water, dust and strong impacts.

## AVOID HIGH TEMPERATURES

Leaving the device in hot or cold places, such as in a closed car in summer or winter conditions, reduces the capacity and lifetime of the battery. For the best results, try to use the device between -20°C and +55°C (-4°F and 131°F). A device with a hot or cold battery may not work temporarily, even when the battery is fully charged.

## PERSONAL MEDICAL DEVICES

Mobile phones may affect the operation of cardiac pacemakers and other implanted equipments. Please avoid placing the mobile phone over the pacemaker, for example in your breast pocket. When using the mobile phone, place it at the ear opposite the pacemaker. If a minimum distance of 15 cm (6 inches) is kept between the mobile phone and the pacemaker, the risk of interference is limited. If you suspect that interference is taking place, immediately turn off your mobile phone. Contact your cardiologist for more information. For other medical devices, consult your physician and the manufacturer of the device. Comply with instructions to switch off the device or deactivate the RF transmitter when required, especially when posted in hospitals and airplanes. Equipment used in these places may be sensitive to radio waves emitted from the device and adversely affect their operation. Also, observe restrictions at gas stations or other areas with flammable atmosphere or when close to electro-explosive devices.

## CHILD SAFETY

Do not allow children to play with your mobile phone or its accessories. Keep it out of their reach. They could hurt themselves or others, or could accidentally damage the mobile phone or accessories. Your mobile phone and its accessories may contain small parts, which could be detached and create a choking hazard.

## EMERGENCY CALLS

Mobile phones operate using radio signals, which cannot guarantee connection under all conditions. Therefore you should never rely solely upon any mobile phone for essential communications (e.g. medical emergencies). Emergency calls may not be possible in all areas, on all cellular networks, or when certain network services and/or mobile phone features are in use. Check with your local service provider.

## WARNING



It is not allowed to connect any external devices to all ports/interface (USB, XPand and SecureAudio Connector) in Hazardous area.

## BATTERY USAGE

Sonim XP5s phone comes with a removable battery. For any battery related queries, contact Sonim customer support.

- Use only a Sonim XP5800 certified battery that is designed for this phone model.
- The use of other batteries may void the warranty terms of your phone and cause damage.
- It is recommended to protect the battery from extreme temperature environments and moisture.
- Please keep the battery out of the reach of children.

## INSERTING THE BATTERY

### 1. UNSCREW COVER

To open the battery cover, rotate both the battery cover screws in a counter clockwise direction (as shown in the figure). Sometimes, the battery cover may be tight and some extra effort is required to open it. You can use the screwdriver provided to open the screws.

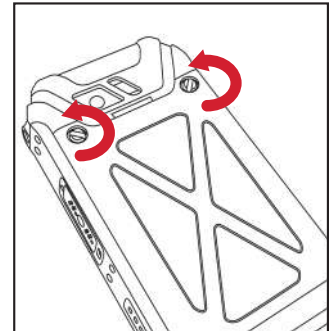

### 2. LIFT THE COVER

Lift the back cover to reveal the battery slot.

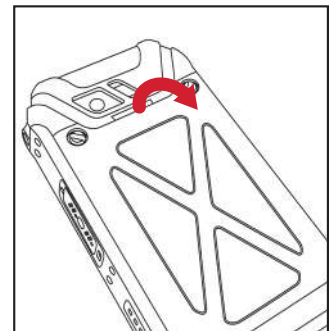

### 3. INSERT BATTERY

Insert the battery and flush into the battery slot such that the three metallic contacts at the bottom of the battery are aligned with the metallic contacts within the battery compartment.

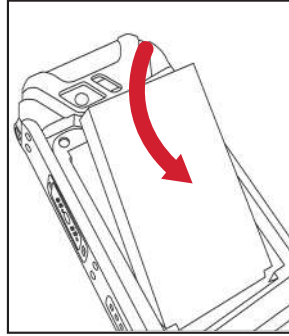

### 4. CLOSE COVER

Close the battery cover. Rotate the battery cover screws in clockwise direction. You can use the screwdriver provided to tighten the screws. Ensure not to over-tighten the screws.

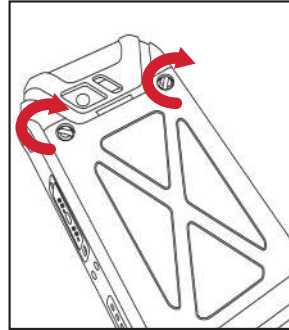

### 1. INSERT CHARGER

Insert the charger plug into a power outlet.

### 2. CONNECT TO THE PHONE

The charging port is located in the lower side of the phone. Insert the charger connector to the charging port.

### 3. CHARGING ANIMATION/ICON

- If the battery is being charged when the phone is switched off, a battery charging animation with current battery level is displayed.
- If the battery is being charged while the phone is switched on, the battery icon on the status bar shows the animation indicating that the battery is being charged.
- Once the battery is fully charged, charging animation is displayed and a pop-up is displayed **“Battery is full. Please unplug the charger”**.



## CHARGING THE BATTERY

The battery delivered with your mobile phone is not fully charged. We recommend that you charge your mobile for 5 hours before you use your mobile phone for the first time.

Only the power supplies with outputs meet the SELV requirements can be used for charging. The maximum allowable input voltage for the phone is 9v.

There is a risk of explosion while charging if the battery has been replaced by an incorrect type.

If the battery is completely out of charge, it can take several minutes for the charging icon to appear when the charger is connected.

For battery Standby, Talk time and usage time, Ideal network conditions are applied as per the standards

## WARNING



ONLY THE BATTERY CAN BE REPLACED in NON-HAZARDOUS LOCATION.

## VERIFYING AND OPTIMIZING BATTERY USAGE

You can check the battery usage status and also close some applications to save battery power. In the all application screen, select **Settings** (⚙) > **Device** > **Battery** (🔋).

The current battery level (charging or not charging) is displayed on the top of the screen. The discharge graph on the top of the screen shows the battery level over time since you last charged the device, and how long you have been running on battery power.

The list at the bottom of the screen shows the breakdown of battery usage for individual apps and services. Select any listed items to view more details. The details screen for some apps includes buttons that allow you to adjust settings affecting power usage, or stop the application completely.

## TIPS TO EXTEND THE BATTERY LIFE

Follow these tips to extend your phone's battery life.

- If you are not using Wi-Fi, Bluetooth, or GPS, use the **Settings** to turn them off. The GPS setting is located in **Settings > Personal > Location**.
- Set screen brightness to **Low** and set a shorter Sleep timeout (15 seconds). The display settings are located in **Settings > Device > Display**.

If you are travelling and do not have access to mobile data or Wi-Fi network, switch to Airplane mode. Select Airplane mode from Quick Settings.



## YOUR SIM CARD

Purchase a SIM card from a mobile operator. The SIM card associates your network services (for example, phone number, data services, and so on) with your phone.

### REMOVING THE BACK COVER

#### 1. UNSCREW COVER

To open the battery cover, rotate both the battery cover screws in counter clockwise direction (as shown in the figure).

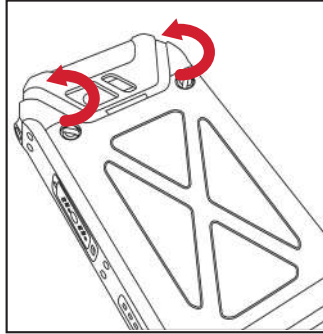

#### 2. LIFT THE COVER

Lift the back cover to reveal the battery slot.

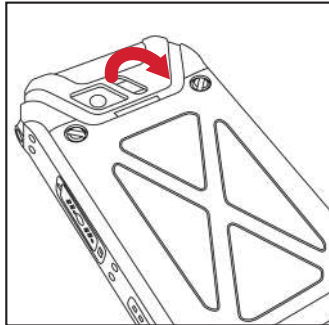

#### 3. USE SONIM SCREWDRIVER

You can use the Sonim provided screwdriver tool to open the screws.

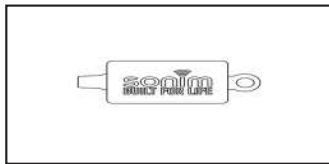

### INSERTING SIM CARDS

#### 1. UNSCREW COVER

Use the included screwdriver to unscrew the two battery cover screws on the back of the phone.

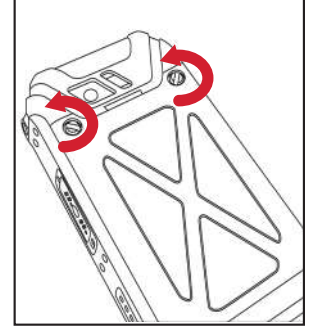

#### 2. LIFT THE COVER

Remove the battery cover and the battery.

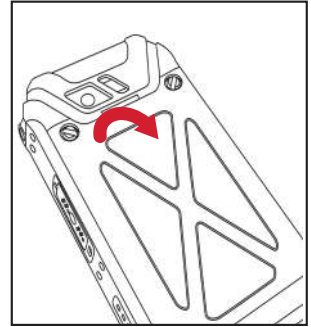

#### 3. INSERT SIM CARD

Open either SIM card tray, insert SIM card and lock SIM card tray into place.

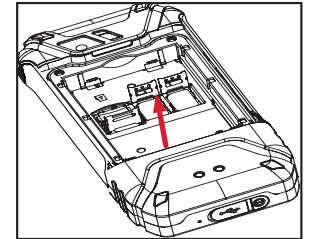

The Sonim XP5s device supports dual SIM. Following are the three scenarios for dual SIM:

- 1. When both the SIM cards are inserted:** At the time of every boot up, a warning/pop-up message is displayed **Device has detected two SIM cards, SIM in Slot 2 will be disabled**. Press **OK** to confirm. SIM with Slot 1 is enabled and SIM in slot 2 is disabled.
- 2. When Only SIM in Slot1 is inserted:** There is no warning/pop-up message is displayed and SIM in slot 1 is active/enabled.
- 3. When Only SIM in Slot2 is inserted:** There is no warning/pop-up message is displayed and message SIM in Slot2 is active/enabled.

## INSERTING MEMORY CARD

### 1. UNSCREW COVER

Use the included screwdriver to unscrew the two battery cover screws on the back of the phone.

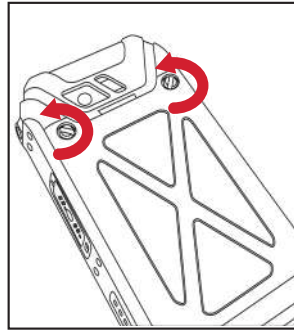

### 2. SLIDE THE SILVER CLIP

Slide (push backward) and lift the silver clip over the designated slot located beside the SIM card slot. (as shown in the figure).

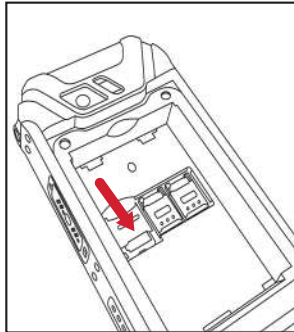

### 3. PLACE THE MEMORY CARD

Place the memory card in the designated slot and close the silver clip. (as shown in the figure).

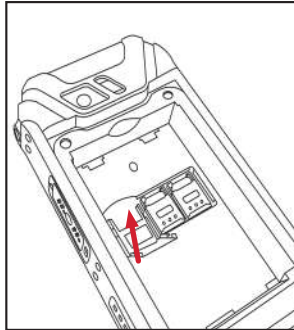

### 4. USE SONIM SCREWDRIVER

You can use the Sonim provided screwdriver tool to open the screws.

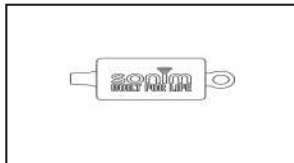

# GETTING STARTED

## WHAT IS IN THE BOX ?

The list of items in the Sonim XP5s phone box are:

- Sonim XP5s
- Battery
- Wall Charger
- USB-C Cable
- Screwdriver
- Quick Start Guide

## PHONE SPECIFICATIONS

FEATURE	DESCRIPTION
Chipset	Qualcomm MSM8920
Band	<b>LTE:</b> B1/B2/B3/B4/B5/B7/B8/B12/B13/B14/B25/B26/B30/B38/B41/B66/ <b>UMTS:</b> B1/B2/B4/B5/B8 <b>GSM:</b> 850/900/1800/1900MHz <b>CDMA:</b> BC0/BC1/BC10
Antenna	MIMO antenna for LTE
Wi-Fi	Support 802.11 a/b/g/n/ac/e/k/r/h Support max 10 connections hotspot
Memory	16GB eMMC 5.1/ 2GB LPDDR3
<b>CONNECTIVITY</b>	
Bluetooth	BT4.x with BLE
Languages Supported	English and Spanish
Capacity(mAh)	3180mAh, removable Li-ion
Battery Life	Standby: up to 267 hours Talk time: up to 19 hours Music playback: up to 59 hours Video playback: up to 8.5 hours Web browsing: up to 7.5 hours
<b>PHYSICAL CHARACTERISTICS</b>	
Ambient temperature	-20°C to +55°C
Size	141mm x 63.9 mm x 23mm

FEATURE	DESCRIPTION
Weight	approx. 248 gms
Dedicated keys	PTT Key/Power Key/Volume key (Up and Down)/Speaker key/Emergency key
Ports	Water-proof USB2.0 type-C, High Speed, OTG
<b>DISPLAY</b>	
Size	2.64"
Resolution	320x432 Transmissive
Outdoor Visibility	Yes
Capacity	262K colors
Brightness	400
<b>AUDIO</b>	
Microphone	3 Mics with noise cancellation
Speaker	Front Dual Loud Speaker, Support HD voice and wideband
<b>MULTIMEDIA</b>	
Audio Formats	AMR-NB, AMR-WB, AAC, AAC+, AAC+V2, MP3, V-SELP, AMR 12.65, AMR 6.6,
Video Formats	3GP, MP4, WMV, AVI, MOV, MPEG-2, MPEG-4, H.263, H.264, H-265
Image Formats	JPEG
Graphic Formats	JPEG, PNG, and BMP
FM Radio	Yes
Camera	5MP FF Rear camera, No front camera
LED Torch Light	Yes, also used for camera flash

## USING YOUR SONIM XP5s



1. Sonim XPand Connector
2. Microphones
3. USB-C
4. Volume Up / Down
5. PTT Button
6. App Tray
7. Options
8. Clear
9. Answer / Accept
10. Voicemail (Press and Hold)
11. Lock Keypad (Press and Hold)
12. Select /Center key
13. Navigation
14. End / Reject / Power On & Off (Press and Hold)
15. Speakerphone
16. Back
17. Display
18. Battery Level Indicator
19. Notification Bar
20. Receiver
21. LED Notification
22. Sonim Secure Audio Connector
23. Emergency Button
24. Charging Pins
25. Battery Under Door
26. SIM Card Slots Under Battery
27. Memory Card Slot Under Battery
28. Battery Door
29. Rear Flash
30. Rear Facing Camera

## SWITCHING ON THE PHONE

Press and hold **ON/OFF** Red button for 2 seconds.

When the phone is switched on, it tries to register with the network. After successful registration, the name of the service provider is displayed.



Ensure that a valid SIM card is inserted in your phone.

## SETTING UP YOUR PHONE

For instructions on using your phone's buttons, charger, battery, and other hardware features, check the printed Quick Start Guide provided along with your phone.

When you power **ON** the phone for the first time, a Welcome screen is displayed.

To set up your phone, select Start and follow the instructions as shown on the screen.

Press **OK** on welcome guide to use the phone.

## MANAGING HOME SCREEN

After you complete the phone setup, the home screen is displayed. The home screen is the beginning point to access all the device's features.

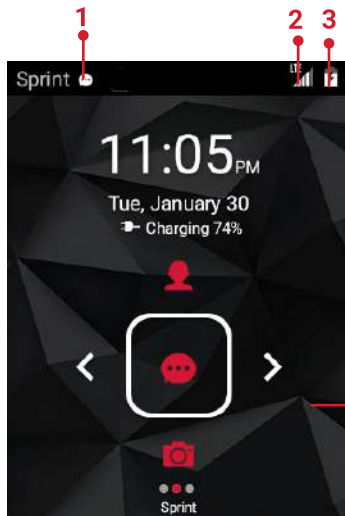

1. Notifications
2. Service Indicator and Signal Strength bar
3. Battery charge indicator and time
4. Home screen

## KEY DESCRIPTION

The navigation keys are located below the display screen.

















KEYS	DESCRIPTION
	<b>Back:</b> Opens the previous screens in the working sequence till the home screen is displayed. Once the home screen is displayed, it remains there even when you press the back key.
	<b>Menu:</b> <ul style="list-style-type: none"><li>• Always positioned in the <b>Center</b> of the keypad. Select to view all the applications and device settings.</li><li>• Long press (2 seconds) to enable torch light.</li><li>• Double press in unlock condition to launch recent screen.</li></ul>
	<b>Options:</b> Displays the options for the currently active screen.
	<b>Clear:</b> Clears the entered text and deletes the selected file.
	<b>Speaker:</b> You can place the call on speaker and this icon is enabled only when call is on the speaker. You can switch the profile when you press and hold the <b>Speaker</b> key for two seconds.
	For better result in a noisy environment, hold the device 15-20 cm from your mouth while speaking on a speaker mode.







The **Notifications** on the top of the display screen provides details about various notifications such as missed calls, new messages and missed alarms.

The **System Icons** on the right display the current device status such as wireless and network connection strength, and battery level.

## NOTIFICATION BAR ICONS

The icons displayed at the top of the screen provides information about the status of the device. The details such as battery charge status, and data service are displayed when the phone is in standby mode. Other indicators such as Bluetooth connectivity status, airplane mode, alarm and call forward (only if Always forward is enabled) and Wi-Fi connectivity are displayed, if the feature is activated.

ICONS	DESCRIPTION
	Notification icon
	Battery level indicator
	Battery charging in progress
	No signal
	Signal strength
	No SIM card
	4G LTE network connected
	Wi-Fi connected
	Bluetooth activated
	Call in progress
	Speaker icon
	FM Radio
	Missed call
	New SMS or MMS
	Alarm activated
	Silent mode activated
	Vibration mode activated

ICONS	DESCRIPTION
	Headset connected
	Missed Events notification
	Flight mode activated
	Error/information notification - attention required
	Screenshot captured
	Music is played
	Device storage space is running out

## PHONE OPERATIONS WITHOUT SIM CARD

You can perform the following operations without inserting a SIM card in your phone.

- Make an emergency call.
- View and modify all settings except few data usage and mobile network related settings.
- Activate and share files through Bluetooth.
- Access the Internet using Wi-Fi connectivity.
- Access your phonebook, File explorer multimedia files, all tools and applications.
- View and modify your profile settings.

## CAPTURING A SCREENSHOT

You can take the screenshot of the current screen and it is stored in your phone's gallery. To take a screenshot:

1. Ensure that the image to be captured is displayed on the current screen.
2. Press the **Power** and **Volume** down button simultaneously. The screenshot is captured and stored in the gallery. A screen **Capture** () icon is also displayed on the notification bar.

## TO CHANGE THE MESSAGE LANGUAGE

While entering the text message or saving the contacts, you can change the message language by press and hold the \* key.

You can change the **Language** from **English** to **Español** and vice versa.

## TEXT ENTRY OPTIONS

When you enter the text message, you can change the text entry options by pressing the # key. The current text entry options are displayed in the top bar.

The various text entry options for text messages are:

- **For English:**
  - **ABC:** Enter all the text in upper case.
  - **Abc:** Enter the first letter of the sentence in upper case.
  - **abc:** Enter all the text in lower case.
  - **123:** Enter the numbers.
  - **T9ABC:** Enter the text based on the T9 dictionary. All the letters are in upper case (capitalized).
  - **T9Abc:** Enter the text based on the T9 dictionary. Only the first letter of the sentence is in upper case (capitalized).
  - **T9abc:** Enter the text based on the T9 dictionary. All the letters are in lower case.
- **For Espanol:**
  - **ESABC:** Enter all the test in upper case (capitalized).
  - **ESabc:** Enter all the text in lower case.
  - **ESAbc:** Enter the first letter of the sentence in upper case.
  - **123:** Enter the numbers.
  - **T9ESABC:** Enter the text based on the T9 dictionary. All the letters is in upper case (capitalized).
  - **T9ESAbc:** Enter the text based on the T9 dictionary. Only the first letter of the sentence is in upper case (capitalized).
  - **T9ESabc:** Enter the text based on the T9 dictionary. All the letters are in lower case.

The various text entry options for adding contacts are:

- **For English:**
  - **ABC:** Enter all the text in upper case.
  - **Abc:** Enter the first letter of the name in upper case.

- **abc:** Enter all the text in lower case.
- **123:** When you place the cursor in the number field, the text entry option is automatically set to numbers. You can enter the numbers.

- **For Espanol:**
  - **ESABC:** Enter all the test in upper case (capitalized).
  - **ESabc:** Enter all the text in lower case.
  - **ESAbc:** Enter the first letter of the sentence in upper case.
  - **123:** Enter the numbers.

## TO ENTER A WORD

1. Start by pressing the numeric keys from 2 to 9 only once for the required letter.
  - Ex 1: To enter the word Good, press 4-6-6-3. The word displays on the screen as you type.
  - Ex 2: To enter the word Hello, press 4-3-5-5-6. The word displays on the screen as you type.
2. If the word does not display correctly, press right navigation key to scroll through alternative word choices. Press either the center navigation key or 0 key to accept the word.

## TO INSERT A NUMBER

1. Press the key labeled with the number you want and use the navigation key to scroll to that number as above.
2. To insert a symbol, press and hold the numeric key 1 and use the navigation key to scroll and select a symbol.

## HOME SCREEN MENU OPTIONS

In order to see the details about any notifications, on the home screen, select **Options key**.

The following options are displayed:

- My Notifications
- Wallpaper
- Search
- Home screen shortcuts
- System settings
- manage apps

## MY NOTIFICATIONS

The left-hand top on your device is where your applications and message services can drop you a note that there is something new to look at, e.g. missed calls, new messages and downloads.

## WALLPAPER

You can set a pre-loaded image or a photo stored in your phone as your home screen wallpaper.

To change the wallpaper, select from one of the following **Wallpaper** collections.

From Home screen, press **Options key > Wallpaper**. Select wallpaper from the popup.

- **Wallpapers:** Includes images that are pre-loaded with the phone.
- **Gallery:** Includes photos and screenshots taken using the phone's camera.

## SEARCH

You can search for people, places, music, movies, history and many more. Enter the key word in the search bar and the list is displayed.

## HOME SCREEN SHORTCUTS

The navigation **Up**, **Center** and **Down** keys are displayed.

For more information, refer “home screen shortcuts” on page 24.

## SYSTEM SETTINGS

System settings refers to the following settings:

- “Managing wireless & network settings” on page 18
- “Managing device Settings” on page 21
- “Managing personal settings” on page 24
- “Managing system Settings” on page 26

## MANAGE APPS

You can manage application and force stop them.

For more information, refer “APPs” on page 22.



## QUICK SETTINGS

---

In order to see the quick settings, on the home screen, select **Left Navigation key**.

The following settings are displayed:

- Wi-Fi
- Bluetooth
- Torch
- Airplane mode
- Profiles

These settings can be enabled or disabled.

### WI-FI

You can enable or disable Wi-Fi settings. For more information, refer “wi-fi” on page 18.

### BLUETOOTH

You can toggle between **ON** and **OFF**. For more information, refer “BLUETOOTH” on page 18.

### TORCH

You can set the **Torch ON** and **OFF**.

### AIRPLANE MODE

Toggle the button to enable or disable the airplane mode. For more information, refer “AIRPLANE MODE” on page 19.

### PROFILES

You can select the profile from the list:

- Standard
- Outdoor
- Silence
- Meeting

For more information, “sound” on page 21

## MISSED EVENTS

---

To view the missed events, on the home screen, select **Right navigation key**.

Missed events are the missed calls or any events which were saved earlier on the device are listed as missed events.

The missed events can be;



- **Missed calls:** When you miss to receive a call, you get a missed event notification.
- **Calendar events:** When you have saved an event like birthday, travel etc, and you missed that event on that particular day, a message is displayed in missed events.
- **New messages:** The unread messages are displayed in missed events.
- **Alarm:** A missed alarm is displayed in missed events.
- **New Voicemail:** A new voice mail is displayed in missed events.

# MANAGING WIRELESS & NETWORK SETTINGS

## WI-FI

Wi-Fi is a wireless network technology that can provide Internet access at distance up to 100 feet, depending on the Wi-Fi router and surroundings.

You can access Internet when you connect your XP5s to a Wi-Fi network. To connect your phone to a Wi-Fi network;

1. From **Home** screen, select **Menu** (  ) > **Settings** (  ).
2. Set the **Wi-Fi** to **ON** position located under **Wireless & networks** settings.
3. Select **Wi-Fi**.  
A list of Wi-Fi access points present within your phone's accessible range are displayed.
4. Select your preferred network. Enter the WEP/WPS/WPA key (if it is a secured network) and select **Connect**. To verify the password before connecting, enable **Show password**.



It is always recommended to make your Wi-Fi network connection secure and also to connect your phone to a secure network.

## ADD NETWORK

1. In **Wi-Fi** settings screen, select **Options key** > **Add network**.
2. Enter the following details:
  - Network SSID: The wireless network ID.
  - Security: Set the security type to None, WEP, WPA/WPA2 PSK, 802.1x EAP.
3. Enable **Advanced options** to set the Proxy details and IP settings.
4. Select **Save** to save the network settings.

## CONNECT TO A NETWORK

1. Press center key on any of the listed network.
2. Enter the password on the prompted window and get connected to the network.

## EDIT A NETWORK

1. Press and hold the connected network.
2. Select **Modify network**. You can change the network password. The other network setting

details such as **Advanced options**, **Proxy**, **IP settings** can be updated.

3. Select **Save** to save the changes.

## FORGET A NETWORK

1. Press and hold the connected network.
2. Select **Forget network**.  
The selected network gets disconnected and displayed in the Wi-Fi list.

If you have to get connected to the same network, enter password.

## ADVANCED

On the Wi-Fi screen, select **Option key** > **Advanced**. The following options are displayed:

- **Install certificates:** You can browse a certificate for installation.
- **Passpoint on:** You can enable the option.
- **Wi-Fi Direct:** Select **Option key** > **Searching** to search for the peer devices and also select **Rename device** to rename the device.
- **WPS Push Button:** Press the **WPS Push Button** in your router, when prompted.
- **WPS Pin Entry:** Enter the given PIN number on your Wi-Fi router.

## CONFIGURE

On the Wi-Fi screen, select **Option key** > **Configure**. The following options are displayed:

- **Network notification:** If you enable this option, it notifies whenever a public network is available.
- **Keep Wi-Fi on during sleep:** You can select any of the following options:
  - Always
  - Only when plugged in
  - Never
- MAC address and IP address are displayed.

## BLUETOOTH

Bluetooth is a short-range wireless communication technology used to communicate between the devices over a distance of about 8 meters.



You can perform the following tasks using Bluetooth paired devices.

- Transfer media files and contacts between connected mobile devices using Bluetooth.
- Use Bluetooth connected headphones for playing media file.

- Bluetooth headset can be used during call.

## PAIRING A BLUETOOTH DEVICE

To activate Bluetooth and pair your XP5s phone with other Bluetooth devices:

1. From **Home** screen, select **Menu** (  ) > **Settings** (  ).
2. Enable **Bluetooth** (  ), located under **Wireless & Networks** settings.

A list of accessible Bluetooth devices are displayed. Ensure that Bluetooth is activated on the other device too.

3. Select your preferred device.
4. To pair with the selected Bluetooth device, select **Pair** in your device. Compare the pairing codes between your device and the other device. The device is displayed in the Paired devices list.



## EDITING PAIRED BLUETOOTH DEVICE SETTINGS

1. Select **Option key** on preferred paired Bluetooth device.
2. Select **Rename this device** to rename the paired Bluetooth device.
3. To unpair the device, select the paired device. Select **Forget** to unpair the device and **Connect** to reconnect with the device.
4. Enable **Media Audio** to connect the Bluetooth device for listening to the media files.

## DATA USAGE

Data usage refers to the amount of data utilized by your phone during data transfers through the Internet. The data usage charges are dependent of the wireless plan provided by your service provider.

To monitor your data usage, adjust your data usage settings.

1. From **Home** screen, select **Menu** (  ) > **Settings** (  ).
2. Select **Wireless & networks > Data usage** (  ).
3. Turn on **Cellular Data** to access Internet using your cellular network
4. **Usage:** You can see the details about the data usage for a particular time frame.
  - **Data saver:** Enable **Data saver** to use apps are allowed to use unrestricted data.
5. Select **Cellular**.
  - **Cellular data:** Enable **Cellular data** to use Internet.



- **Cellular data usage:** Displays the data usage for a particular time frame.
- **Billing cycle:** Billing of the used data is displayed here.
  - You can enable the **Set data warning** to get the warning message when your data usage is crossed the present limits.
  - **Data warning** shows the data available for a particular time frame.
  - Enable **Set data limit** to set the data usage limit.
- 6. Select **Wi-Fi > Wi-Fi data usage**. When Wi-Fi is enabled, it shows the data used for a particular time frame.
  - **Network restrictions:** The background data is restricted for these networks. While downloading apps, you receive a warning message for these restricted networks.

## MORE

### AIRPLANE MODE



When your phone is set in airplane mode, network connectivity or mobile data connectivity is disabled. But you can access your camera, media files and other features that do not require data connectivity.

To activate airplane mode:

1. From **Home** screen, select **Menu** (  ) > **Settings** (  ).
2. Select **More** (  ) located under **Wireless & networks** settings.
3. Enable **Airplane** mode.

### TETHERING & PORTABLE HOTSPOT



You can share you device's mobile data connection via USB or mobile hotspot.

1. From **Home** screen, select **Menu** (  ) > **Settings** (  ).
2. Select **Wireless & network > More** (  ) > **Tethering & portable hotspot**.
3. Enable **USB tethering**. This is enabled only when USB is connected to the device.
4. **Portable Wi-Fi hotspot:** Enable **Portable Wi-Fi hotspot**.
  - **Set up Wi-Fi hotspot:** You can set up a Wi-Fi hotspot by entering the following details:
    - **Network name:** Enter the network name.
    - **Security:** Select the security from the drop-down list.
    - **Password:** The password must have at least 8

characters.



- **Select AP Band:** You can select either **2.4 GHz Band** or **5 GHz Band** from the drop-down list.
  - **Broadcast network name (SSID):** If you switch the Broadcast Network Name (SSID) off, your device will not be visible to the other devices.
  - Select **Save** to save the settings.
  - **Maximum Connections:** The maximum number of devices which can be connected to the Wi-Fi hotspot are ten.
  - **Wi-Fi Hotspot Power Mode:** You can select one of the options:
    - Auto disable Mobile Hotspot after 5 minutes of inactivity
    - Auto disable Mobile Hotspot after 10 minutes of inactivity
    - Do not disable Mobile Hotspot due to inactivity
  - **Connected Devices:** The devices which are connecting to the Hotspot are displayed here.
5. **Bluetooth Tethering:** When you activate Bluetooth tethering, you can share your phone's Internet connection with other Bluetooth paired devices.

## VPN

1. From **Home** screen, select **Menu** (  ) > **Settings** (  ).
2. Select **Wireless & Networks > More** (  ) > **VPN**.
3. Select **Options key > Add VPN profile**.
4. In **Edit VPN profile** screen, enter the **Name**, **Type** (select from the drop-down list), and the **server address**.
5. Enter **Username** and **password**.
6. Select **Save**.



## CELLULAR NETWORKS

You can view and set your mobile service provider settings.

1. From **Home** screen, select **Menu** (  ) > **Settings** (  ).
2. Select **Wireless & networks > More** (  ) > **Cellular networks** .  
You can use mobile data services such as web browsing and other services over the cellular network.  
The following options are displayed:
  - **Preferred network type:** You to can to set to the to network to mode to **Automatic**.
  - **Roaming:** You can change voice, text and data roaming including international roaming.



- **Access point names:** You can view the access points related to your SIM provider.
- **Network operators:** You can view the available networks. Also, you can search for the networks and choose the network automatically.

## NETWORK SETTINGS RESET



1. From **Home** screen, select **Menu** (  ) > **Settings** (  ).
2. Select **Wireless & Networks > More** (  ) > **Network settings reset**.
3. Select **RESET SETTINGS**.  
It reset all the network settings including Wi-Fi, Cellular data, and Bluetooth.

# MANAGING DEVICE SETTINGS

## DISPLAY

- From **Home** screen, select **Menu** (  ) > **Settings** (  ) > **Device** > **Display** (  ).
- Set one of the following options to configure your phone's display:
  - **Brightness level:** Set the brightness of the phone display. This also optimizes the battery power consumed.
  - **Wallpaper:** Set the wallpaper for your home screen. You can select from one of the following wallpaper collections:
    - **Gallery:** includes photos and screenshots taken using the phone's camera.
    - **Wallpapers:** includes images that are pre-loaded with the phone.
  - **Sleep:** Set the sleep time so that the screen brightness is turned down after specified time of phone inactivity. This setting also optimizes the battery power.
  - **Font size:** Set the font size of the text displayed in the screen.

## SOUND

- From **Home** screen, select **Menu** (  ) > **Settings** (  ) > **Device** > **Sound** (  ).
- Select **Profile** and the following options are displayed:

OPTION	DESCRIPTION
1. <b>Standard</b>	Set to <b>Standard</b> and select <b>Option key &gt; Edit</b> . The following options are displayed:
<b>Sound</b>	<ul style="list-style-type: none"> <li>• You can set Media volume, Ring volume, Alarm volume, Phone ringtone, Default notification ringtone.</li> <li>• You can enable the <b>Vibrate when ringing</b>.</li> </ul>
<b>Other Sounds</b>	You can set <b>Screen lock sounds, Charging sounds, and key press tones</b> .



OPTION	DESCRIPTION
<b>Notification</b>	<ul style="list-style-type: none"> <li>• If Pulse LED light is enabled, battery status indication is not affected.</li> <li>• If Flash notification alert is enabled, when battery is above 20% level, you can use camera flash light for missed events.</li> <li>• If Flash call alert is enabled, you can use Flash camera light for incoming voice call.</li> </ul>
2. <b>Outdoor</b>	Set to <b>Outdoor</b> and select <b>Option key &gt; Edit</b> . The following options are displayed:
<b>Sound</b>	<ul style="list-style-type: none"> <li>• You can set Media volume, Ring volume, Alarm volume, Phone ringtone, Default notification ringtone.</li> <li>• You can enable the <b>Vibrate when ringing</b>.</li> </ul>
<b>Other Sounds</b>	You can set <b>Screen lock sounds, Charging sounds, and key press tones</b> .
<b>Notification</b>	<ul style="list-style-type: none"> <li>• If Pulse LED light is enabled, battery status indication is not affected.</li> <li>• If Flash notification alert is enabled, when battery is above 20% level, you can use camera flash light for missed events.</li> <li>• If Flash call alert is enabled, you can use Flash camera light for incoming voice call.</li> </ul>
3. <b>Silence</b>	Set to <b>Silence</b> and select <b>Option key &gt; Edit</b> . The following options are displayed:

OPTION	DESCRIPTION
Sound	When set to <b>Silence</b> mode, this profile blocks all sounds and vibrations including alarms, videos, and games. You will be able to make phone calls.
Notification	<ul style="list-style-type: none"> <li>• If Pulse LED light is enabled, battery status indication is not affected.</li> <li>• If Flash notification alert is enabled, when battery is above 20% level, you can use camera flash light for missed events.</li> <li>• If Flash call alert is enabled, you can use Flash camera light for incoming voice call.</li> </ul>
<b>4. Meeting</b>	Set to <b>Meeting</b> and select <b>Option key &gt; Edit</b> . The following options are displayed:
Sound	You can set Media volume, and Alarm volume.





Apart from default profiles, user can create customized profiles.

To create a new profile,

1. From **Home** screen, select **Menu** (  ) > **Settings** (  ) > **Device** > **Sound** (  ).
2. Select **Profiles** > **Option key** > **Create new**.
3. Enter the required **profile name**.  
Maximum length of 24 characters is allowed for the profile name and the name should be unique.
4. Before modifying the necessary sound and notification settings, save the new profile.

#### QUICK PROFILE SWITCH

1. From **Home** screen, select **Menu** (  ) > **Settings** (  ) > **Device** > **Sound** > **Profile** (  ).
2. Select **Quick Profile Switch**.  
You can use this option to quickly switch profiles via home screen shortcut and Speaker key.  
You can switch the profile when you press and hold the Speaker key for two seconds.

#### SOUND

- **Media Volume:** You can increase, decrease, and mute media volume.
- **Alarm volume:** You can increase, decrease or mute the alarm volume.
- **Ring volume:** You can change the ringer volume to no ringer or ringing.
- **Also vibrate for calls:** Enable this option to set the device on vibration for calls.
- **Phone ringtone:** You can select the required ringtone from the list.
- **Default notification ringtone:** Set the default notification ringtone from the list.

#### OTHER SOUNDS

- **Screen lock sounds:** Enable or disable this option.
- **Charging sounds:** Enable or disable this option.
- **Key press tones:** Enable or disable this option.



#### NOTIFICATION

- **Pulse LED light:** If Pulse LED light is enabled, Pulse LED light is used to display notification alert and the battery status indication is not affected.
- **Flash notification alert:** If Flash notification alert is enabled, when battery is above 20% level, you can use camera flash light for missed events.
- **Flash call alert:** If Flash call alert is enabled, you can use Flash camera light for incoming voice call.



#### VOICE NOISE CANCELLATION

By default, FENS is enabled and reduces the noise cancellation.



#### APPS

1. From **Home** screen, select **Menu** (  ) > **Settings** (  ) > **Device** > **Apps** (  ).
2. Select **All apps** drop-down list. You can select any of the following options:
  - All apps
  - Enabled
  - Disabled
3. Select the required app from the list. Open the app and select **FORCE STOP**.
4. Select the app and press **Options key**. The following options are displayed:
  - Advanced
  - Show system
  - Reset app preferences



## USB POWER SAVING

1. From **Home** screen, select **Menu** (  ) > **Settings** (  ) > **Device** > **USB Power Saving** (  ).
2. **Automatic Power ON:** If enabled, the device gets automatically power ON when the USB is connected.
3. **Automatic Power OFF:**
  - **Automatic Power OFF:** If enabled, the device gets automatically power OFF at set time.
  - **Power off device at:** If you enable Automatic power off, this option will be active. You can set the time for the device to be power off.
  - **Automatic power OFF:** If this is enabled, upon USB disconnection, the device gets powered off after the set hours.
  - **On USB disconnect, power off:** You can set the hours for the device to be powered off once the USB is disconnected.

## STORAGE

1. From **Home** screen, select **Menu** (  ) > **Settings** (  ) > **Device** > **Storage** (  ).
2. On **Internal shared storage**, the following options are displayed with memory used for each app:
  - Shows the used memory
  - Apps
  - Images
  - Videos
  - Audio
  - System
  - Other
  - Cached data
  - Explore

## BATTERY



1. From **Home** screen, select **Menu** (  ) > **Settings** (  ) > **Device** > **Battery** (  ).
2. Set the **Battery saver ON** by selecting the option given for Turn on automatically:
  - Never
  - at 5% battery
  - at 15% battery





Battery saver turns off automatically when your device is charging.

You can also view the battery usage data.

## MEMORY

1. From **Home** screen, select **Menu** (  ) > **Settings** (  ) > **Device** > **Memory** (  ).
2. Go to **Memory** and select the time from the drop-down list. You can view the applications usage based on the set time frame.
3. Select **Memory used by apps** to check the memory used for each application for the set time frame.



## GESTURE

1. From **Home** screen, select **Menu** (  ) > **Settings** (  ) > **Device** > **Gesture** (  ).
2. Enable **Toggle Torch**.
3. To quickly toggle torch, shake the device twice.

# MANAGING PERSONAL SETTINGS



## HOME SCREEN SHORTCUTS

You can set the shortcuts on the home screen.

1. From **Home** screen, select **Menu** (  ) > **Settings** (  ) > **Personal**.
2. Select **Home screen shortcuts** (  ).
3. Go to the **Navigation up key** and select the app to be set for the up key navigation.
4. Go to the **Navigation center key** and select the app to be set for the center key navigation.
5. Go to the **Navigation down key** and select the app to be set for the down key navigation.



## EMERGENCY INFO

You can enter the emergency information to be viewed during an emergency.

1. From **Home** screen, select **Menu** (  ) > **Settings** (  ) > **Personal**.
2. Select **Emergency Info** (  ).
3. Go to **My information** and enter the following details:
  - First name
  - Last name
  - Phone number
  - Email address
  - Address
  - Blood type
  - Allergies
  - Medication
  - Organ donor
4. If you do not want to enter any of the above details, select **Skip**.
5. Go to **Add** and you can select the contact from the the phonebook by selecting **Select contact**.  
OR
6. Select **Add > Add new**. Add **First name**, **Last name**, and **Phone number**. Select **Add**.  
This contact is added under Emergency contacts list.



## LOCATION

You can enable and configure the Location settings.

1. From **Home** screen, select **Menu** (  ) > **Settings** (  ) > **Personal**.
2. Select **Location** (  ). Enable and modify required security settings.
3. Set the **Location Mode** to one of the following options:
  - **High accuracy:** uses AGPS, Wi-Fi, mobile networks, and other sensors to get the highest-accuracy location for your device. It uses location help to estimate your location faster and more accurately.
  - **Battery saving:** allows your device to estimate your location using low battery-intensive location sources, such as Wi-Fi and mobile networks. It uses location help to estimate your location faster and more accurately.
  - **Device only:** allows your device to estimate your location using GPS only. It uses the satellite information to provide location information. This mode may use more battery power and take longer time to determine your location.
4. You can also view the apps which have requested location recently under **Recent location requests**.

## SECURITY

You can activate and protect your phone from unauthorized access by configuring the security settings.



1. From **Home** screen, select **Menu** (  ) > **Settings** (  ) > **Personal**.
2. Select **Security** (  ).
3. Select **Device security > Screen lock** and select one of the following options to configure the phone:
  - None
  - Press and hold \* key
  - **PIN:** When enabled, enter you own PIN value. When the phone is locked, unlock it using the PIN. When the phone is locked, you can answer an incoming call, without unlocking the phone.
4. **Encryption:** By default, the phone is already encrypted.
5. **SIM card lock:** Select **Set up SIM card lock** to view the SIM settings.
  - **Lock SIM card:** You can set a PIN and use the phone for security purpose.
  - **Change SIM PIN:** You can change the SIM PIN.



6. **Passwords:** Enable **Make passwords visible** option to view the password characters.
7. **Device administration:**
  - **Device administrators:** You can view or deactivate the device administrator.
  - **Unknown sources:** When enabled, it allows installing the apps from unknown sources.
8. **Credential storage:**
  - **Storage type:** Displays the storage type.
  - **Trusted credentials:** You can view and verify the system and user certificates.
  - **Install from SD card:** You can view and install new user certificates from SD card.
  - **Clear credentials:** You can remove all certificates.
9. **Advanced:**
  - **Trust agents:** To use this option, a screen lock should be set.
  - **Apps with usage access:** Select the app and select center key to enable/disable the **Permit usage access**.



## PROGRAMMABLE KEY

You can assign any application to the programmable key.

1. From **Home** screen, select **Menu** (  ) > **Settings** (  ) > **Personal**.
2. Select **Programmable key** (  ).
3. Select any application from the list for assigning to the Programmable key.

## LANGUAGES & INPUT

You can set the phone's language to any of the languages displayed in the language list.



1. From **Home** screen, select **Menu** (  ) > **Settings** (  ) > **Personal**.
2. Select **Languages & input** (  ).
3. Go to **Languages** and select any language from the list as your preferred language.  
The following languages can be set as a preferred language:
  - English
  - Español
 All the menu items and user feedback messages will get displayed in the set language.
4. Select **Keyboard & input methods > FlexT9 Text Input**.
  - **Input languages:** You can set the input language to either **English** or **Español**.
  - **Personal Dictionary:** The default keyboard input

language is set to English (US)/Spanish (US). This cannot be modified. You can add a custom word to the personal dictionary.

- **Preferences:**
    - **Auto-capitalization:** The first letter of the new sentence is automatically capitalized.
    - **Auto-punctuation:** If this option is enabled, when you press the space key twice at the end of the word to insert a period.
    - **Language switch key:** Press and hold the \* key to switch the language.
    - **Next Word Prediction:** Predicts a next word based on the previous word entered.
    - **Suggest contact names:** Displays suggested contact while typing.
5. Select **Support > FlexT9 Help**. It displays FlexT9 help guide.  
Select **Support > About**. It displays the FlexT9 version details.
  6. Text-to-speech-output: Select **Speech > Text-to-speech output**.
    - **Preferred engine:** The preferred engine is set.
    - **General:** You can adjust the **Speech rate** and **Pitch**. Reset the speech rate and speech pitch. You can demonstrate a speech synthesis. English is set as default language status.

## FACTORY RESET



You can erase all the data from your phone's internal storage.

1. From **Home** screen, select **Menu** (  ) > **Settings** (  ) > **Personal**.
2. Select **Factory Reset** (  ).
3. You can erase all data from your phone's internal storage which includes;
  - System and app data and settings
  - Downloaded apps
  - Music
  - Photos
  - Other user data

# MANAGING SYSTEM SETTINGS

## DATE & TIME

You can set and display the date and time on the phone. You can also select the display format.

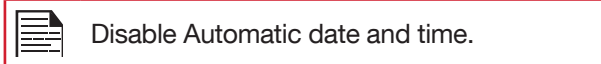

1. From **Home** screen, select **Menu** (  ) > **Settings** (  ) > **System**.
2. Select **Date & time** (  ).
3. Select the following options to configure phone:
  - To synchronize the date and time with the network provided time, enable **Automatic date & time**.
  - To synchronize the time zone with the network provided time, enable **Automatic time zone**.
  - To set the date manually, select **Set date**. Scroll and select the date, month and year. Select **OK**.  
You can save the changes for set time manually.



- To set the time manually, select **Set time**. Scroll and select the hour and minute. Select **OK**.
- To set the time zone, select **Select time zone**. Scroll and select your time zone.
- To set the clock to 24-hour format enable **Use 24-hour format**. By default, the phone is set to **12-hour format**.



## ACCESSIBILITY

You can make websites and applications more accessible to people with disabilities when they are using mobile phones and other devices.



1. From **Home** screen, select **Menu** (  ) > **Settings** (  ) > **System**.
2. Select **Accessibility** (  ).
3. Select **Services**.
  - **SCOUT by AetherPal**: Enable the privacy feature of Remote Management Service by moving the toggle to **ON**.
  - **Talkback**: When Talkback is enabled, it helps vision-impaired users interact with their devices. It uses spoken word, vibration and other audible feedback to let you know what is on your screen.
4. Select **System**.
  - **Captions**: When Captions is **ON**, you can set the following options under **Standard options**:
    - Language
    - Text size
    - Caption style

- **Persistent Alert**: Turn **ON** to set an alert for a particular app.
  - **Repeat Interval**: Select the required time interval to set the alert for a particular app: 15 Seconds, 30 Seconds, 60 Seconds, 90 Seconds, and 120 Seconds.
  - **Select Application**: Check the box next to the required application from the list to set the persistent alert.
- **Font size**: You can set the font size from smaller to bigger and see the preview of the same.
- **High contrast text**: If this option is enabled, you can see the text changes into the contrast colors.
- **Mono Audio**: Enable **Mono audio** to combine the channels when playing audio.
- **Vibrate on Keypress**: If this option is enabled, on each key press, the device is vibrated.
- **Sound balance**: You can adjust the left and right volume balance.
- **Text-to-speech output**:
  - **Preferred engine**: The preferred engine is set.
  - **General**: You can adjust the **Speech rate** and **Pitch**. Reset the speech rate and speech pitch. You can demonstrate a speech synthesis. English is set as default language status.

## ABOUT PHONE

1. From **Home** screen, select **Menu** (  ) > **Settings** (  ) > **System**.
2. Select **About phone** (  ).
3. The following information is displayed:
  - Status
  - Legal Information
  - Model
  - Firmware version
  - Firmware security patch level
  - Hardware version
  - Baseband version
  - Kernel version
  - Build number

## SYSTEM UPDATES

1. From **Home** screen, select **Menu** (  ) > **Settings** (  ) > **System**.
2. Select **System Updates** (  ).
3. The following options are displayed which are client initiated system update option:
  - Update Profile
  - Update PRL
  - Update Firmware
  - UICC Unlock

## MANAGING CONTACTS

You can use the phonebook to maintain phone numbers of your contacts. This feature enables you to add contacts, dial phone numbers and send SMS and MMS messages.

To access the contacts, from **Home** screen, select **Contacts** (  ). The contacts saved in the phonebook are displayed.





### ADDING A NEW CONTACT FIRST TIME

After inserting the SIM, when you switch **ON** the device for the first time and there are no contacts added in the device or SIM.



You have only two options here:

- **Add Contact:** **Add New contact** screen is displayed. Enter all the details and select **Options key > Save** to save the contact.
- **Import Contacts:** Select **Import Contact** to import from .vcf file or import from SIM card.

### ADDING A NEW CONTACT

1. From **Home** screen, select **Menu** (  ) > **Contacts** (  ).
2. To add a new contact, select **Menu > Contacts > Option key > Add contact**. Enter the contact details and select **Option key > Save** to save the contact.
3. You can also enter a number using dialpad and select **Add to contact** (  ) and then **Create new contact** (  ) to add a new contact. Select **Option key > Save** to save the contact.

### VIEWING CONTACT DETAILS

1. From **Home** screen, select **Menu** (  ) > **Contacts** (  ).
2. Scroll to the required contact and select the contact to view the contact details.

### SENDING A MESSAGE FROM CONTACTS

You can send SMS and MMS messages to the contacts.

1. From **Home** screen, select **Menu** (  ) > **Contacts**



(  ).

2. Scroll to the required contact and open it.
3. Select **Option key > Send message**.
4. Enter the message and select **Option key > Attach photos/videos** to attach the photos and videos.
5. Select **Option key > Send**.



If you attach a media file or a contact to your SMS message it is converted to an MMS message automatically.

## DIALING A NUMBER FROM CONTACTS

1. From **Home** screen, select **Menu** (  ) > **Contacts** (  ).
2. Scroll to the required contact and select the contact to view the details.
3. Select the number and press **Center** key to initiate the call. **OR**
4. Select the required contact from the list and press the green button on the phone to initiate the call.

## EDITING THE CONTACT DETAILS

1. From **Home** screen, select **Contacts** (  ).
2. Scroll to the required contact and select the contact to view the details.
3. Select **Option key > Edit**.
4. Edit the required details. Select **Option key > Save** to save the details.

## MENU OPTIONS

On the **Contacts** screen, select **Options key** to view the menu options. Following are the menu options:

### ME:



1. Select **Me** and a screen is displayed to add device owner's name, Phone number and an email id.
  - Select **Options key** and you have the following options:
    - **Send message:** You can select either email or the phone number to send a message.
    - **Edit:** You can edit the contact details.
    - **Share:** You can share your contact details via **Messaging** and **Bluetooth**. The contact is shared as .vcf file.
    - **Copy to SIM:** You can copy the contact from the device to SIM.
    - **Send Contact:** The contact is sent as a text message to the selected contact.

## ADD CONTACT

You can add a new contact by entering all the details. Select **Options key > Save** to save the contact.

## IMPORT/EXPORT



### IMPORT FROM .VCF FILE

1. From **Home** screen, select **Menu** (  ) > **Contacts** (  ).
2. Select **Option key > Import/export**.
3. Select **Import from .vcf file**.
4. Press **Center** key to select the .vcf file to be imported.
5. Select **OK**.  
The contact is imported to the list.





If the device has only one vcf file, it is imported without any selection window.

### IMPORT FROM SIM CARD

1. From **Home** screen, select **Menu** (  ) > **Contacts** (  ).
2. Select **Option key > Import/export**.
3. Select **Import from SIM card**.  
The list of contacts stored in your SIM card are displayed.
4. Select the contact to be moved to the phone.
5. Select **Option key > Done**.
6. A confirmation message is displayed. Select **OK** to confirm.  
The contact is imported to the phone address book.

### EXPORT TO SIM CARD

1. From **Home** screen, select **Menu** (  ) > **Contacts** (  ).
2. Select **Option key > Import/export**.
3. Select **Export to SIM card**.
4. Select the contact to be exported from Phone to SIM card.
5. Select **Option key > Done**.  
The contact is exported to the SIM card.



### EXPORT TO .VCF FILE

1. From **Home** screen, select **Menu** (  ) > **Contacts** (  ).

2. Select **Option key > Import/export**.
3. Select **Export to .vcf file**.
4. Press **Center** key to select the contact to be exported.
5. Select **Option key > Done**.  
A message is displayed for the location, where the .vcf file saved.
6. Select **OK** to confirm.  
The .vcf file is exported to the device internal memory.

## SHARE ALL CONTACTS

You can send contact information in two ways:

1. From **Home** screen, select **Menu** (  ) > **Contacts** (  ).
2. Select **Option key > Import/export**.
3. Select **Share all contacts**. You can use one of the following options to share the required contact:
  - **Messaging:** Send the contact details as a multimedia message to any mobile phone.
  - **Bluetooth:** Send the contact details to a Bluetooth device paired or available devices with your phone. Select the Bluetooth device to share the contact.

## BLOCKED NUMBERS



You cannot receive either a call or a text message from the blocked number.

## SELECT

You can select the required contacts by checking the boxes next to the contact.



## SETTINGS

You can set the sort list to view the contacts and also the first or last name of the contact to be displayed first.



1. From **Home** screen, select **Menu** (  ) > **Contacts** (  ).
2. Select **Options key > Settings**. Set the following options:
  - **Sort by:** Sort the contact names by first name or last name.
  - **Name format:** Set the contact display name to first name or last name.

## MANAGING CONTACT SETTINGS

You can edit and modify ringtone and call receiving settings for individual contacts.

1. From **Home** screen, select **Menu** (  ) > **Contacts** (  ).
2. Scroll to the required contact and select the contact to view the contact details.
3. Select **Options key** and select one of the following:
  - **Set Ringtone** to set a specific ringtone for that contact.
  - Check the option **All calls to voicemail** to forward all incoming calls from that contact to your voice-mail box.

## DELETING A CONTACT

1. From **Home** screen, select **Menu** (  ) > **Contacts** (  ).
2. Scroll to the required contact and select the contact to view the contact details.
3. Select **Options key** > **Delete** or press **Clear** (  ) key. The contact is deleted after the confirmation.



# MANAGING CALL SETTINGS

## MAKING A CALL



To make a call,

- Enter the phone number from the dialpad and initiate a call.  
OR
- Press **Green key** (  ) or from **Menu > Phone** and the **Call history** can be viewed.  
The phone screen with last dialed number, missed calls and received calls are displayed.
- The call can be initiated from the **Call History**.

## DIALING A NUMBER VIA CONTACT

1. From **Home** screen, select **Menu** (  ) > **Contacts** (  ).
2. Scroll to the contact and select the contact. The contact details are displayed.
3. Select the required phone number to call the contact.

## ADDING A CONTACT FROM HOME SCREEN

1. From **Home** screen, enter the required number to be dialed.
2. Select **Add to contact** (  ).
3. Select **Create new contact** (  ).
4. In the **Add new contact** screen, add the name and other details for the contact.
5. Select **Option key > Save**.  
The contact is saved.

## VIEWING CALL HISTORY

1. From **Home** screen, select **Phone** (  ).
2. The **Recent calls** screen displayed with recently called, received, and missed calls.

## DELETING CALL HISTORY

1. From **Home** screen, select **Phone** (  ).
2. On the **Recent calls** screen, select **Option key > Delete selected call log**.  
OR

Press **Clear** (  ) key on the keyboard to delete the selected call log.

3. A confirmation message is displayed to delete the

selected call log. Select **Delete** to delete the call log. The selected call log is deleted.

## SHOW MISSED CALLS

With this option, the user can view the missed calls history.

1. From Home screen, select **Phone** (  ).
2. On Recent calls screen, select **Option key > Show missed calls**.
3. The calls which you have missed are displayed under **Missed calls**.

## SPEED DIAL SETTINGS

With this option, the user can assign a contact to each key present in the keypad (2 to 9). Long press the keypad to initiate a call to the assigned contact.

To set the speed dial,

1. From Home screen, select **Phone** (  ).
2. On Recent calls screen, select **Option key > Speed dial** settings.
3. Assign a contact for each key present in the keypad (2 to 9). Key 1 is used for voicemail.
4. Long press a particular keypad to initiate a call to the assigned contact.

## CALL SETTINGS

To view and modify call settings,

1. From Home screen, select **Phone** (  ).
2. On Recent calls screen, select **Option key > Call settings**. Different settings are:

## QUICK RESPONSES

When you are not able to answer an incoming call, you can send a quick response to the caller. To view and edit quick responses, select **Call settings > Quick responses**. Select the specific response message to edit. Edit the message and select **OK**.

## CALLS

### I. Calling Accounts:

### SIP SETTINGS

- **SIP Accounts:** To add a SIP account and configure your incoming and outgoing preferences:
1. In the **Call settings** screen, select **Calling accounts > SIP accounts**.

2. Enable Receive incoming calls to answer incoming Internet calls.  
This might reduce your phone's battery life.
  3. Select **Option key > Add account** to configure a new SIP account.
  4. Enter the following details and select **Option key > Save** to save the account:
    - **Username:** Username to login to SIP account.
    - **Password:** Password to login to SIP account.
    - **Server:** SIP server details.
    - **Optional Settings:** Select to view/modify or hide optional details such as authentication username, display name, outbound proxy address, port number, transport type and Send keep alive options.
- **USE SIP CALLING**
    - Select **Calling accounts > Use SIP calling**.
    - A dialog is open with the following options:
    - **For all calls:** If this option is selected and when the phone is connected to Wi-Fi network or mobile Internet, each dialed call becomes an Internet call.
    - **Only for SIP calls:** If this option is selected, only SIP call can be dialed.
  - **RECEIVE INCOMING CALLS**  
Enable Receive incoming calls to answer incoming Internet calls.  
  
This might reduce your phone's battery life.

## II. VOICEMAIL:

- **Service:** Displays the Service name. It is displayed as My carrier.
- **Setup:** You can set a number for voicemail.
- **Sound:** Set the sound from the list.
- **Vibrate:** Check the box to set it to vibrate.

## III. Fixed Dialing Numbers:

- **Enable FDN:** Fixed Dialing numbers are enabled.
- **Change PIN2:** Change the PIN for FDN access.
- **FDN List:** Manage phone number list.

## IV. GSM Call Settings:

These are the additional GSM call settings.

- **Call Forwarding:** You can forward your incoming calls to a number in the contacts or a new number, provided your network operator supports this service. Select one of the following call forward options:

SETTINGS	DESCRIPTION
<b>Always forward</b>	Forward all incoming calls to a pre-designated number.
<b>When busy</b>	Forward calls when your phone is busy.
<b>When unanswered</b>	Forward calls when you do not answer incoming calls.
<b>When unreachable</b>	Forward calls when your phone is switched off or is out of coverage area.

- **Additional Settings:**
  - **Caller ID:** You can choose Network default, Hide number, or Show number.
  - **Call waiting:** When call waiting is enabled and the phone is in conversation, the incoming number is displayed when you receive a call. To activate call waiting in the **Call settings** screen, select **Additional settings**. Enable **Call waiting**.
  - **Call Barring:**

SETTINGS	DESCRIPTION
<b>Outgoing call barring</b>	You can select any of the options for call barring: <b>Outgoing call</b> , <b>International call</b> , and <b>International roaming call</b> .
<b>Incoming call barring</b>	You can select either <b>All calls</b> or <b>Roaming calls</b> .
<b>Cancel all call barring</b>	You can cancel the callbarring option for all the calls.
<b>Change password</b>	You can change the password.

## V. CDMA Call Settings:

These are the additional CDMA call settings.

- **Call forwarding:**
- **Call waiting:**

## CALL BLOCKING

You will not receive calls or messages from the blocked numbers.

## ACCESSIBILITY

If you enable TTY mode, hearing-impaired individuals can send and receive phone calls as text over the phone.

### TTY MODE

1. In **Call settings** screen, select **Accessibility > TTY mode** to view and modify TTY mode settings.
2. Set one of the following options:
  - **TTY Off:** disables TTY mode.
  - **TTY Full:** enables TTY mode for both incoming and outgoing calls. Set this for both hearing and voice assistance.
  - **TTY HCO:** enables TTY mode only for incoming calls. Set this for only hearing assistance.
  - **TTY VCO:** enables TTY mode only for outgoing calls. Set this for only voice assistance.

### HEARING AIDS

1. In **Call settings** screen, select **Accessibility > Hearing aids**.
2. Check the box to turn on hearing aid compatibility.



## SENDING MESSAGES

SMS and MMS are convenient and inexpensive means of communication. You can send a text message to other people via SMS service. MMS allows you to send messages by including multimedia content such as pictures, audio files, video files, and so on.

You can use the Messaging in your phone to send an SMS and MMS message to other mobile phones or any other equipment that can receive SMS and MMS.



The MMS feature is available only if you subscribe it from your network operator.

To access the message function, from **Home** screen, select **Messaging** (  ).

### SENDING SMS/MMS MESSAGE

You can send SMS and MMS messages to contacts in your phonebook and to new numbers that are not present in the phonebook.

1. To create a SMS message, from **Home** screen, select **Messaging** (  ).
2. Select **Option key > New message**.
3. Enter the contact name or the phone number in the **To** field.

If you enter an alphabet, all the contact names starting with that alphabet and containing that alphabet are displayed as a list. Scroll down to select the contact.

4. Enter the message.

When you add an attachment, the message is automatically converted to a multimedia message. MMS charges will apply, based on the operator.

5. You can add any multimedia attachment up to the size of  $\leq 1$  MB. To add an attachment, select **Options key > Attach photos/videos**. Browse to a specific folder and select the multimedia file to be attached.
6. Select **Option key > Attach others**. Select the attachment type from the options in the next step.

ATTACHMENT TYPE	DESCRIPTION
<b>Capture picture</b>	Take a new photo using the mobile camera and attach.
<b>Capture video</b>	Take a new video using the camcorder and attach.
<b>Audio</b>	Attach an audio file from the phone memory.
<b>Record audio</b>	Record a new audio using the sound recorder and attach.
<b>vCard</b>	Attach a contact available in the phone.
<b>vCalendar</b>	Attach a calendar event.
<b>Slideshow</b>	Create new slideshow or edit the existing slides and attach.

### MANAGING MESSAGE SETTINGS

You can customize the way you want to view and filter the messages.

To view and modify the message settings,

1. To edit message settings, from **Home** screen, select **Messaging** (  ).
2. Select **Option key > Settings**.
3. View and edit the following settings:

SETTINGS	DESCRIPTION
<b>NOTIFICATION</b>	
<b>Vibrate</b>	Enable vibrate alert for incoming messages.
<b>DISPLAY</b>	
<b>Group notification message</b>	Enable this notification message to auto combine the notifications into one group.
<b>STORAGE</b>	
<b>Delete old messages</b>	Delete old messages automatically when the storage limit is reached.
<b>Text message limit</b>	Set the maximum number of SMS messages to be stored.
<b>Multimedia message limit</b>	Set the maximum number of MMS messages to be stored.
<b>Memory status</b>	Shows the memory used for SMS, MMS and the total memory used.
<b>ADVANCED SETTINGS</b>	
<b>Text (SMS) messages settings</b>	
<b>Delivery reports</b>	Request a delivery request for each message you send
<b>Pre-set messages</b>	Edit pre-set messages
<b>SMS signature</b>	Enable your SMS signature
<b>Edit SMS signature</b>	Edit SMS signature
<b>Manage SIM card messages</b>	Manages the messages in the SIM card located under <b>Text Messages</b> .
<b>SMS Validity Period</b>	Set SMS validity period from the list: Not set, 1 hour, 6 hours, 12 hours, 1 day, and maximum
<b>Enable WAP PUSH Service</b>	Enable to receive service message.

## DELETING MESSAGES

To delete all the messages,

1. From **Home** screen, select **Messaging** (  ).
2. Select the message and press **Option key >** **Delete selected thread** or select a message thread and press **Ok** to delete the message.
3. A confirmation message is displayed. Select **Delete** to delete the selected message.
4. To delete an individual conversation, select the conversation to be deleted and select **Delete** option and confirm the choice.

## EMERGENCY ALERTS

You receive active alerts and emergency alerts from the service provider.

## SPRINT DIRECT CONNECT PLUS

---

Your Sonim phone comes with pre-loaded SDC Plus application.

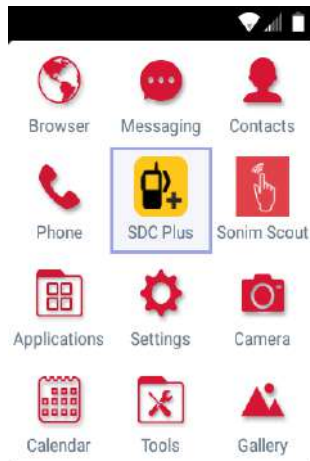



For more information on **SDC Plus** application, refer to the link:

<https://www.sprint.com/content/dam/sprint/commerce/services/sprint-direct-connect-plus/documents/sdc-plus-ug-android.pdf>

## SONIM SCOUT

Sonim SCOUT is a solution that allows the user to register with Sonim and use a number of key enterprise features.

To access Sonim Scout,

- From **Home** screen, select **Menu** (  ) > **Sonim Scout** (  ).

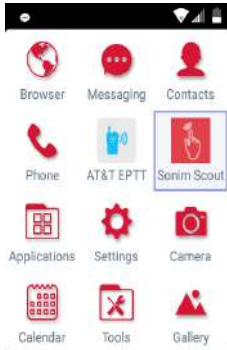

## SETUP

Setup tab consists of the following features:

- SonimSetupWizard
- SafeGuard
- App Updater

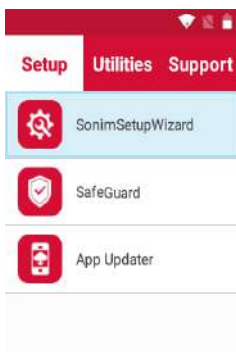

## UTILITIES

Utilities tab consists of the following features:

- Contact Transfer
- Sonim BLE Connect

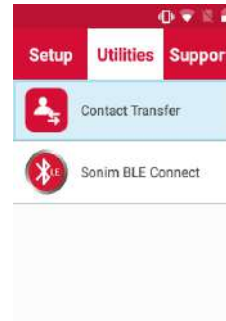

## SUPPORT

Support tab consists of the following features:

- Chat
- Remote Control
- SonimCare
- Warranty Registration
- Device Information
- Contact Sonim Support
  - Call
  - Email

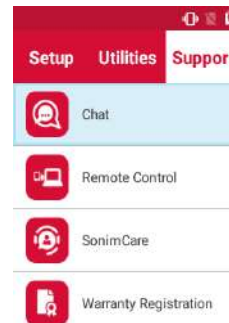

# APPLICATIONS

## MUSIC



You can play music files and voice memos stored in your phone using the music application.

From **Home** screen, select **Menu** (  ) > **Applications** (  ) > **Music** (  ).

- Select **Artists** to view the music files sorted based on the artists.
- Select **Albums** to view the music files sorted based on the albums.
- Select **Songs** to view the complete list of songs stored in your phone.
- Select **Playlists** to access the default playlists in the music folder.
  - Select **Recently added** playlist to view the music files that are recently added to the music folder.
  - Select **My recordings** playlist to access all your voice memo files.

## FM RADIO

You can listen to the radio through FM radio. A wired Headset should be connected to enable FM radio.



1. To listen to the radio, select **Menu** (  ) > **Applications** (  ) > **FM Radio** (  ).
2. A message **Please plug in a Headset to use FM Radio** is displayed. Connect a wired Headset with the side connector to enable FM Radio. **FM radio** icon is displayed on the **Notification** bar.
  - **Side Connector:** As the Sonim XP5s device does not support the jack, side connector is used to plug-in the jack and listen to FM radio over the headset.



3. Select **Options** > **Auto Scan** to scan all the stations. Available channels are displayed.
4. Select **Options** > **Setting** and the following options are displayed:
  - Regional Band
  - Audio Output Mode
  - Alternate Frequency
  - Revert to Factory Defaults

## FILE EXPLORER

You can view/edit/delete/share the files stored in the phone through **File Explorer** (  ).

To view the files, select **Menu** (  ) > **Applications** (  ) > **File Explorer** (  ).

Select any folder and press **Option key** to view the following options:

5. **Recent:** Displays the recent files captured or stored.
  - **Share:** Share the file or folder via Messaging/Bluetooth.
  - **Delete:** Delete the existing folder.
  - **Copy to:** Copy the contents of the folder.
  - **Move to:** Move the contents of folder.
  - **Properties:** View the properties of the folder.
  - **Select:** Select a particular folder. **Downloads:** Displays the downloaded files.
  - **Exit:** You can select Exit option for exiting from current folder.
6. **Downloads:** Displays the different folder under Downloads.
  - **Share:** Share the file or folder via Messaging/Bluetooth.
  - **Delete:** Delete the existing folder.
  - **Copy to:** Copy the contents of the folder.
  - **Move to:** Move the contents of folder.
  - **Rename:** Rename the existing folder.
  - **Properties:** View the properties of the folder.
  - **Select:** Select a particular folder.
  - **Sort by:** You can sort the folder using **Sort** option. Sorting options are; **By Name**, **By Date Modified** and **By Size**.
  - **New folder:** You can create a new folder.
  - **Exit:** You can select **Exit** option for exiting from current folder.
7. **XP5800:** Displays the different folder in the device drive.
  - **Search:** Search for the file and folder.
  - **Delete:** Delete the existing folder.
  - **Copy to:** Copy the contents of the folder.

- **Move to:** Move the contents of folder.
- **Rename:** Rename the existing folder.
- **Properties:** View the properties of the folder.
- **Select:** Select a particular folder.
- **Sort by:** You can sort the folder using **Sort** option. Sorting options are; **By Name, By Date Modified** and **By Size**.
- **New folder:** You can create a new folder.
- **Exit:** You can select **Exit** option for exiting from current folder.





If SD card is inserted, all the files in the SD card can be view/edit/delete/share from file explorer.

## BACKUP AND RESTORE

If you need to replace your device or erase its data, you can restore your data for any accounts that were previously backed up.

To back up your data,

1. From **Home** screen, select **Menu** (  ) > **Applications** (  ).
2. Select **Backup and Restore** (  ).
3. Select **Backup**.  
All your contacts, Calendar, SMS and MMS data will be backed up and media content like photos, audio and videos are moved to SD card.

A warning message is displayed **Backup may take few minutes. Please do not perform other operations during this time.**

Select OK to start the backup.



4. Select **Restore**.  
The contacts, Calendar, SMS and MMS are restored.



Without SD card, the user cannot take device back-up.



## DOWNLOADS

Use the Downloads screen to view, open, or delete the downloaded files.

1. From **Home** screen, select **Menu** (  ) > **Applications** (  ).
2. Select **Downloads** (  ).
3. Select **Options** > **Select** to select the downloaded file to be opened, Viewed, or deleted.

## MOBILE URGENT ALERTS





**Mobile Urgent Alerts** is a personal safety service enabling field personnel, lone workers, or people at risk to immediately notify response teams.

1. From **Home** screen, select **Menu** (  ) > **Applications** (  ).
2. Select **Mobile Urgent Alert** (  ).  
Scroll to the right to view more option:
3. Select **Send multiple alerts**.  
You can send multiple alerts to your pre-selected alert contacts through text message.
4. Select **Call for HELP**.  
You can dial a call in addition to sending mobile urgent alerts to your selected contacts.
5. Select **Automatic fall detection**.  
This feature is used by the personnel who work in high and risky places. When there is a fall, alerts can be sent to the contacts.
6. Select **SIGN UP**.
7. Enter your phone number and select **NEXT**.

## TOOLS





### CLOCK

You can view the time of major cities in different time zones using this function.

1. From **Home** screen, select **Menu** (  ) > **Tools** (  ).
2. Select **Clock** (  ).
3. Select **World clock icon** (  ) located on the top of the screen. To add a city , select **Option key > Add city**. Select the check boxes next to the cities to add them to the **Clock**.  
Added cities are listed in alphabetical order.
  - The local time in the home city is displayed in the upper half of the screen.
  - To set the home city, select the required city from the list. It is added to the selected cities list. The selected city is set as the home city.

### ALARM





You can set an alarm for a particular time.

1. From **Home** screen, select **Menu** (  ) > **Tools** (  ).
2. Select **Clock** (  ).
3. Select **Alarm** activation icon (  ) on the top of the screen.
4. Select **Option key > Add** to add a new alarm.
5. To set a recurring alarm, select **Option key > Edit**.  
You can choose and set the following options:
  - **Time:** You can set the required time.
  - **Repeat:** You can select the days in a week to repeat the alarm for all the selected days.
  - **Alarm Ringtone:** Select the alarm ringtone.
  - **Label:** You can name the alarm.
  - **Vibrate:** You can enable the device to vibrate when the alarm is set.
6. Select any of the ringtones from the **Default alarm tone sound** present, and select **OK**.

### STOPWATCH



1. From **Home** screen, select **Menu** (  ) > **Tools** (  ).
2. Select **Clock** (  ) > **Stop watch** (  ).
3. Select **START** and **STOP** to run the stop watch.

### TIMER

1. From **Home** screen, select **Menu** (  ) > **Tools** (  ).
2. Select **Clock** (  ) > **Timer** (  ).
3. The following actions can be performed:
  - RESET, START, STOP, and LAP

## CALCULATOR





The default calculator in this phone is designed to perform simple mathematical calculations and the advanced panel for scientific calculations.

1. From **Home** screen, select **Menu** (  ) > **Tools** (  ) > **Calculator** (  ).
  - To enter the numbers, select the numeric keys.
  - To use mathematical operators, select the respective operation key on the keypad.
  - Select = for the final result.
2. Select **Option key > Advanced panel** for scientific calculations.  
You can toggle between **Basic panel** and **Advanced panel**.

## SOUND RECORDER

You can record voice memos using the sound recorder.

To access the sound recorder,

- From **Home** screen, select **Menu** (  ) > **Tools** (  ) > **Sound Recorder** (  ).
  - To record an audio file, select **Record** (  ).
  - To stop the recording, select **Stop** (  ).
  - To save the voice memo, press down arrow key and select **Save**.
  - To exit without saving, press down arrow key and select **Discard**.
  - To play the recorded file instantly, press right arrow key and select the file to be played. Press **center** key to play the voice memo.

## SIM TOOLKIT

It displays the Operator specific services.

To access the SIM Toolkit,





- From **Home** screen, select **Menu** (  ) > **Tools** (  ) > **SIM Toolkit** (  ).
- It displays the SIM provider and the respective services details.

## OTHER APPLICATIONS

---

### CAMERA



The Sonim XP5s has a rear camera with 5MP fixed focus for capturing pictures. The pictures are saved in the **Gallery**.

1. From **Home** screen, select **Menu** (  ) > **Camera** (  ).
2. Select **Camera** mode to set the following modes:
  - **Normal** (  ): To shoot a picture in normal mode, press **center** key to capture the picture. Use **Left** and **Right** navigation keys for **Zoom in** and **Zoom out**. You can use **Volume Up** and **Down** key to capture the image.
  - **Video** (  ): Press **center** key to start/stop a video recording. You cannot pause the recording in the middle.
3. Select **Option** key to view or change camera settings such as **Flash**, **Exposure**, and **File Format** etc.

### CALENDAR

The Calendar helps you to set appointments, schedule reminders and alerts and repeat them if required. You can also view your saved tasks on a daily or weekly basis.

To access calendar;

1. From **Home** screen, select **Menu** (  ) > **Calendar** (  ).
2. To change the calendar view, choose **Month** or **Agenda** from **Options** menu.
3. Select **Options** key to view the list of the following available options:
  - **Today**: Access current date events.
  - **New event**: New event can be added on selecting this option.
  - **Agenda**: Select each agenda and to view the event details.
  - **Search**: You can search for a particular event.
  - **Delete Events**: Select the **event** > **Option key** > **Done** to delete the selected event. Select **Select all** to delete all the events.

When you have an event, the **Delete events** option is enabled.

- **Settings**:
  - Displays the **General settings** of the calendar.
  - Displays the **Build version** in **About Calendar**.



### GALLERY

The pictures and videos are captured from the camera are stored in **Gallery** and can be viewed later.

From **Home** screen, select **Menu** (  ) > **Gallery** (  ).

You can view the photo album, screenshots, and the individual pictures.

### BROWSER

1. From **Home** screen, select **Menu** (  ) > **Browser** (  ).
2. Enter the URL to search for the required information or any website.



## REGULATORY INFORMATION - USA MARKET

---

### RF EXPOSURE INFORMATION (SAR)

This device meets the government's requirements for exposure to radio waves.

This device is designed and manufactured not to exceed the emission limits for exposure to radio frequency (RF) energy set by the Federal Communications Commission of the U.S. Government.

The exposure standard for wireless device employs a unit of measurement known as the Specific Absorption Rate, or SAR. The SAR limit set by the FCC is 1.6W/kg. \*Tests for SAR are conducted using standard operating positions accepted by the FCC with the device transmitting at its highest certified power level in all tested frequency bands. Although the SAR is determined at the highest certified power level, the actual SAR level of the device while operating can be well below the maximum value. This is because the device is designed to operate at multiple power levels so as to use only the power required to reach the network. In general, the closer you are to a wireless base station antenna, the lower the power output.

The highest SAR value for the model device XP5800 (Type number PG2112) as reported to the FCC:

- when tested for use at the ear is 0.98W/kg, and
- when worn on the body, as described in this user guide, is 1.35W/kg (Body-worn measurements differ among device models, depending upon available accessories and FCC requirements.)

While there may be differences between the SAR levels of various devices and at various positions, they all meet the government requirement.

The FCC has granted an Equipment Authorization for this model device with all reported SAR levels evaluated as in compliance with the FCC RF exposure guidelines. SAR information on this model device is on file with the FCC and can be found under the Display Grant section of [www.fcc.gov/oet/ea/fccid](http://www.fcc.gov/oet/ea/fccid) after searching on FCC ID: WYPPG2132.

For body worn operation, this device has been tested and meets the FCC RF exposure guidelines for use with an accessory that contains no metal and be positioned

a minimum of 1.5cm from the body. Use of other accessories may not ensure compliance with FCC RF exposure guidelines. If you do not use a body-worn accessory and are not holding the device at the ear, position the handset a minimum of 1.5cm from your body when the device is switched on.

### FEDERAL COMMUNICATION COMMISSION INTERFERENCE STATEMENT

This device complies with part 15 of the FCC Rules. Operation is subject to the following two conditions:

- This device may not cause harmful interference, and
- This device must accept any interference received, including interference that may cause undesired operation.

This device has been tested and found to comply with the limits for a Class B digital device, pursuant to Part 15 of the FCC Rules. These limits are designed to provide reasonable protection against harmful interference in a residential installation. This equipment generates, uses, and can radiate radio frequency energy, and, if not installed and used in accordance with the instructions, may cause harmful interference to radio communications. However, there is no guarantee that interference will not occur in a particular installation. If this equipment does cause harmful interference to radio or television reception, which can be determined by turning the equipment off and on, the user is encouraged to try to correct the interference by one or more of the following measures:

- Reorient or relocate the receiving antenna.
- Increase the separation between the equipment and receiver.
- Connect the equipment into an outlet on a circuit different from that to which the receiver is connected.
- Consult the dealer or an experienced radio/TV technician for help.

## FCC CAUTION

- Any Changes or modifications not expressly approved by the party responsible for compliance could void the user's authority to operate the equipment.
- The antenna(s) used for this transmitter must not be co-located or operating in conjunction with any other antenna or transmitter.

## HAC RATING

The FCC has created a rating system for cellular phones regarding their HAC-related performance. This rating helps consumers with hearing disabilities to find phones that work well with their hearing aid devices. The HAC rating and measurement procedure are described in the American National Standards Institute (ANSI C63.19-2011) contains two rating standards: an "M" rating from 1 to 4 for hearing aids operating in microphone mode, and a "T" rating from 1 to 4 for hearing aids operating in tele coil mode. M-Rating stands for Microphone rating and indicates the amount of reduction of RF interference between the telephone and the hearing aid in acoustic coupling mode (also called microphone mode). Phones rated M3 or M4 meet FCC requirements and generate less interference to hearing devices set in microphone mode. T-Rating stands for tele coil rating and represents inductive coupling with hearing aids that are operating in telecoil mode. A tel coil is a small piece of tightly wrapped wire, built into some hearing aids.

microphone of a hearing aid picks up all sounds, the telecoil only picks up an electromagnetic signal from the telephone. Thus, users of telecoil-equipped hearing aids are able to communicate over the telephone without the amplification of unwanted background noise. Phones rated T3 or T4 meet FCC requirements and generate less interference to hearing devices set in telecoil mode. A combination of M-rating and T-rating defines the final HAC rating and is a deciding factor in selecting cellular phones for people with hearing problems. A HAC compliant phone could be rated:

- M3/T3
- M3/T4
- M4/T3
- M4/T4

These ratings assist hearing device users to find phones that are compatible with their hearing devices. Ratings are shown on the phone's box or label. The ratings are not guaranteed for suitability. The results vary depending on the individual's hearing loss and the immunity characteristics of the used hearing device, i.e.

its resistance to interference. The best way to evaluate the suitability of the phone is to try it with the intended hearing aid device.

The model XP5800 have been tested for hearing aid device compatibility and complies with the Federal Communications Commission (FCC) requirements.

These devices are rated M3/T4.

## ISED RF EXPOSURE STATEMENT (IC)

This EUT is compliance with SAR for general population/uncontrolled exposure limits in IC RSS-102 and had been tested in accordance with the measurement methods and procedures specified in IEEE 1528 and IEC 62209. This equipment should be installed and operated with minimum distance 1.5 cm between the radiator and your body. This device and its antenna(s) must not be co-located or operating in conjunction with any other antenna or transmitter.

Cet appareil est conforme aux limites d'exposition DAS incontrôlée pour la population générale de la norme CNR-102 d'Industrie Canada et a été testé en conformité avec les méthodes de mesure et procédures spécifiées dans IEEE 1528 et IEC 62209. Cet appareil doit être installé et utilisé avec une distance minimale de 1.5cm entre l'émetteur et votre corps. Cet appareil et sa ou ses antennes ne doivent pas être co-localisés ou fonctionner en conjonction avec tout autre antenne ou transmetteur.

## HAZARDOUS LOCATION USAGE WARNING

Determine by inspection that the following information is made available to the user by one or more of;

- (a) Printed on the label for the battery
- (b) Printed on the label for the host device,
- (c) Printed in the owner's manual, and/
- or (d) Posted in a help file or Internet web site.



Do not disassemble or open crush, bend or deform, puncture or shred.



Do not modify or remanufacture, attempt to insert foreign objects into the battery, immerse or expose to water or other liquids, expose to fire, explosion or other hazard.



Only use the battery for the system for which it is specified.



Only use the battery with a charging system that has been qualified with the system per CTIA Certification Requirements for Battery System Compliance to IEEE 1725. Use of an unqualified battery or charger may present a risk of fire, explosion, leakage, or other hazard.



Do not short circuit a battery or allow metallic conductive objects to contact battery terminals.



Replace the battery only with another battery that has been qualified with the system per this standard, IEEE-Std-1725. Use of an unqualified battery may present a risk of fire, explosion, leakage or other hazard. Only authorized service providers shall replace battery. (If the battery is non-user replaceable).



Do not short circuit a battery or allow metallic conductive objects to contact battery terminals.



Promptly dispose of used batteries in accordance with local regulations.



Battery usage by children should be supervised.



Avoid dropping the phone or battery. If the phone or battery is dropped, especially on a hard surface, and the user suspects damage, take it to a service center for inspection.



Improper battery use may result in a fire, explosion or other hazard.

# INDEX

---

## A

- Accessibility 26
- Account Sync 30
- Airplane Mode 19
- Alarm
  - Timer 39
- Applications
  - Music
  - FM Radio
  - File Explorer 13, 14, 16, 23
- APPs 22

## B

- Backup 38
- Battery
  - Insert
  - Remove 23
- Battery usage
  - Charging 7
- Blocked numbers 28
- Bluetooth
  - Pairing 19
- Browser 40

## C

- Calculator 39
- Calendar 40
- Capturing a Screenshot 14
- Cellular Data 19
- Contacts
  - Export
  - Import
  - Share 18, 27, 28, 29

## D

- Data warning 19
- Date 26
- Display 21
- Downloads 38

## E

- Emergency alerts 34
- Emergency info 24
- Encryption 24

- Export 28

## F

- Factory reset 25
- File explorer 37
- FlexT9 Text 25
- FM radio 37

## G

- Gesture 23

## H

- HAC 42
- Hazardous location 43, 44
- Home Screen 13
- Hotspot 19

## I

- Import 28

## K

- Keyboard 25
- Keyboard Dictionaries 36

## L

- Language 25
- Location 24

## M

- Memory
  - App usage 23
- Messages 33
- Missed Events 17
- Mobile Network 19
- Mobile Urgent Alerts
  - Automatic fall detection 38
  - Multiple Alerts 38
- My Notifications 16

## N

- Noise Cancellation
  - FENS 22
- Notification 22

## O

Operations 14

## P

Phone language 15

Phone specifications 11

Power Optimization 7

Programmable key 25

## Q

Quick Profile Switch 22

Quick Settings 17

## R

Restore 38

## S

Scout

Setup

Utilities

Support 38

Search 16

Security 24

Security Settings 24

Setup wizard 36

SMS/MMS Message 33

Sound 21

Sound Recorder 39

Stopwatch 39

Storage

Internal Share 23

## T

Tethering 19

Text Entry 15

Time 26

Toggle Torch 23

Torch 17

## U

USB Power saving 23

## V

VPN 20

## W

Wallpaper 16

Wi-Fi 18

WPS 18

## X

XP5s 12